



DALI SPECIFICATION GUIDE

	Page		Page
1. INTRODUCTION	6	5. APPLICATIONS WITHOUT PROGRAMMING	17
2. DALI - THE STANDARD	6	5.1. Manual switching and regulation, push-button interface and push-button	17
2.1. Industry standard	6	5.2. Manual switching and regulation, infrared control	18
2.2. Light control	6	5.3. Manual switching and regulation, infrared control, push-button interface and switch	19
2.3. Digital control	7	5.4. Daylight-controlled light regulation, automatic	20
2.4. Switching in the electronic ballast	8	5.5. Daylight-controlled light regulation, with manual control, switch 230V	21
2.5. Addressability	8	5.6. Daylight-controlled light regulation, with manual control, switch module and switch	22
2.6. Light groups	8	5.7. Daylight-controlled light regulation, with infrared remote control	23
2.7. Simple installation	9	5.8. Movement-controlled lighting, fully automatic	24
2.8. Characteristics of DALI	9	5.9. Movement-controlled lighting, with manual control, switch 230V	25
3. DALI SYSTEM	10	5.10. Movement-controlled lighting, with manual control, switch module and switch	26
3.1. System description	10	5.11. Movement-controlled lighting, with infrared remote control	27
3.2. Switch and sensor lines	10	5.12. Daylight regulation and movement-controlled lighting, fully automatic	28
2.1 Structure	11	5.13. Daylight regulation and movement-controlled lighting, switch 230V	29
2.2 Sensor line lengths to suit practical needs	11	5.14. Daylight regulation and movement-controlled lighting, with manual control, switch module and switch	30
2.3 Maximum line lengths	12	5.15. Daylight regulation and movement-controlled lighting, with manual control, infrared remote control	31
4. APPLICATIONS / OVERVIEW	13	5.16. Daylight regulation and movement-controlled lighting, with manual control, infrared remote control and push-button interface	32
4.1. Routing	13		
4.2. Overview: Which function with which sensors, no programming	14		
4.3. Overview: Which function with which sensors, with programming	15		
4.4. Explanation of symbols	16		

	Page		Page
6. APPLICATIONS WITH PROGRAMMING	33	7. PROGRAMMING THE TRIOS DALI	47
6.1. Manual switching and regulation, push-button interface and push-button	33	7.1. Defining terms	47
6.2. Manual switching and regulation, infrared control	34	1.1. Luminaire group	47
6.3. Manual switching and regulation, infrared control, push-button interface and switch	35	1.2. IR channel	47
6.4. Daylight-controlled light regulation, automatic	36	1.3. PRESET	47
6.5. Daylight-controlled light regulation, with manual control, switch 230V	37	1.4. Group	48
6.6. Daylight-controlled light regulation, with manual control, switch module and switch	38	7.2. Allocating addresses and assigning them to a luminaire group	49
6.7. Daylight-controlled light regulation, with infrared remote control	39	7.2.1. Addressing with IRT 1090	49
6.8. Movement-controlled lighting, with manual control, switch module and switch	40	2.2. Addressing with IRT 8050	50
6.9. Movement-controlled lighting, with infrared remote control	41	7.3. Dimming channels and defining PRESETS	51
6.10. Daylight regulation and movement-controlled lighting, fully automatic	42	3.1. Remote control IRC 2130	51
6.11. Daylight regulation and movement-controlled lighting, switch 230V	43	3.2. Group setting IRC 2130	52
6.12. Daylight regulation and movement-controlled lighting, with manual control, switch module and switch	44	3.3. Wall-mounted remote control IRT 8050	53
6.13. Daylight regulation and movement-controlled lighting, with manual control, infrared remote control	45	3.4. Group setting IRT 8050	53
6.14. Daylight regulation and movement-controlled lighting, with manual control, infrared remote control and push-button interface	46	3.5. Function setting IRT 8050	54
		3.6. Push-button interface LCU 8020	55
		7.4. TRIOS activation/deactivation behaviour	56
		8. NOTES ON DAYLIGHT-CONTROLLED LIGHT REGULATION	57
		8.1. Difference between "control" and "regulation"	57
		8.2. Principle of the light regulation circuit	57
		8.3. Daylight-dependent switching or dimming?	58
		8.4. Tips for positioning the light sensor	58
		4.1 Light sensor recording range	59
		4.2 Light regulation with lateral windows	59
		4.3 Regulation of overhead lights	61
		8.5. Multiple regulation zones in a single room	61
		8.6. Daylight-controlled regulation	62
		6.1. Master / slave programming	63
		6.2. Setting the required value	63
		9. PRODUCT OVERVIEW	65

1.

Introduction

This documentation shows the technical possibilities of the DALI system for specific applications. It provides a detailed account of the numerous functions offered depending on the system's sensor configuration.

2.

DALI - the standard

The new standard of the DALI protocol (Digital Addressable Lighting Interface) defines digital communication between electronic ballasts and control units. When defining the standard, a firm option was taken not to develop a complex building control system with maximised functional capabilities, but to create instead a simple system with clearly defined structures. DALI is not designed for a complex bus system, but rather for intelligent, high-performance light management in a single room. These functions can of course be integrated into a building management system by means of suitable interfaces.

2.1

Industry standard

To ensure full compatibility between DALI components from different manufacturers, the DALI protocol is being standardised globally in accordance with IEC 929. This will create the basis for marketing and using DALI components worldwide without encountering vendor-specific, national, or technical incompatibilities. This standard is supported by globally-active and renowned companies.

2.2

Light control

Since the DALI protocol has been designed for rooms requiring professional light management, the following functions have been defined:

- Switching on / off** Individual DALI electronic ballasts, groups or all electronic ballasts in a single system can be switched on / off.
- Dimming** The dimmable electronic DALI ballast is equipped with a technical facility for dimming the lamp current logarithmically from 100% to 0.1% in 125 dimming steps (in practice, the lower dimming level is set at 3% so as to ensure that the lamp service life is not compromised).
- Light scenes** Up to 16 light scenes can be programmed and retrieved in a single DALI system.
- Status display** The DALI protocol can also be used to display and / or retrieve statuses of the electronic ballast or lamp.

2.3. Digital control

The electronic ballasts are connected to the controller via two wires. Data packets consisting of 19 bits enable the controller to communicate with the electronic ballasts at a rate of 1200 bauds per second.

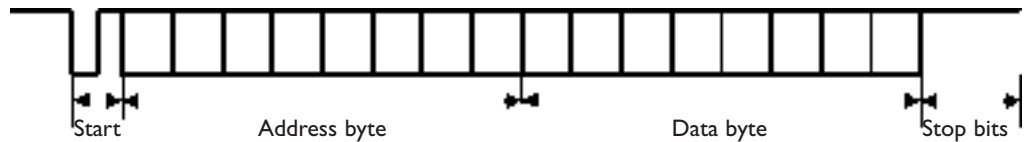

Figure 1

The DALI line has a voltage of 16 V, with the tolerances shown in the diagram.

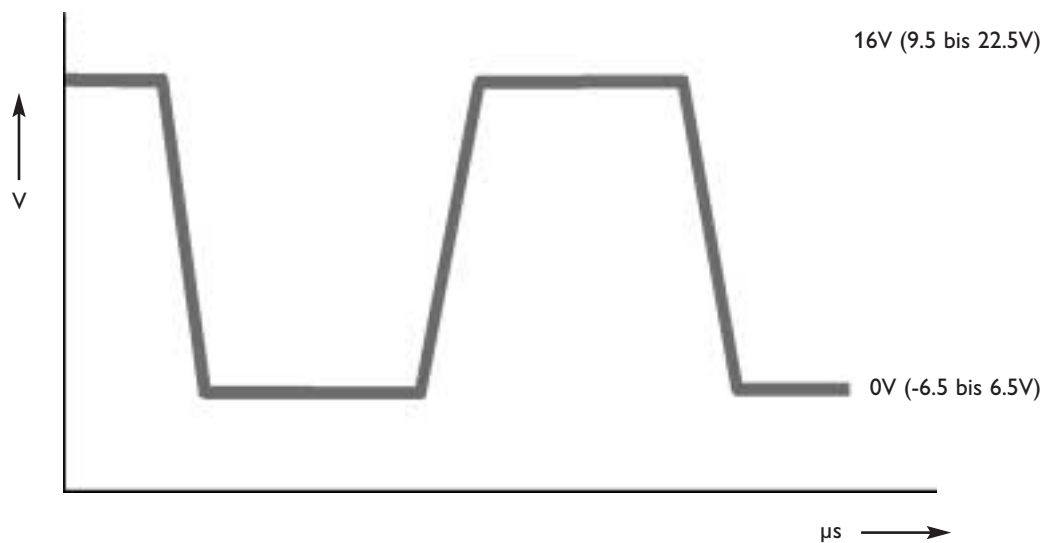

Figure 2

The maximum current in a DALI system is limited to 250 mA in accordance with IEC 929. The current consumption per electronic ballast is set at 2mA. Giving maximum of 125 ballasts in a DALI installation.

2.4. Switching in the electronic ballast

The lamp is switched on / off in the electronic ballast. This means that there is no longer need to use power switches to interrupt the circuit. The 230 V supply voltage is always available at the electronic ballast and light can be switched or dimmed by means of a command via the DALI line.

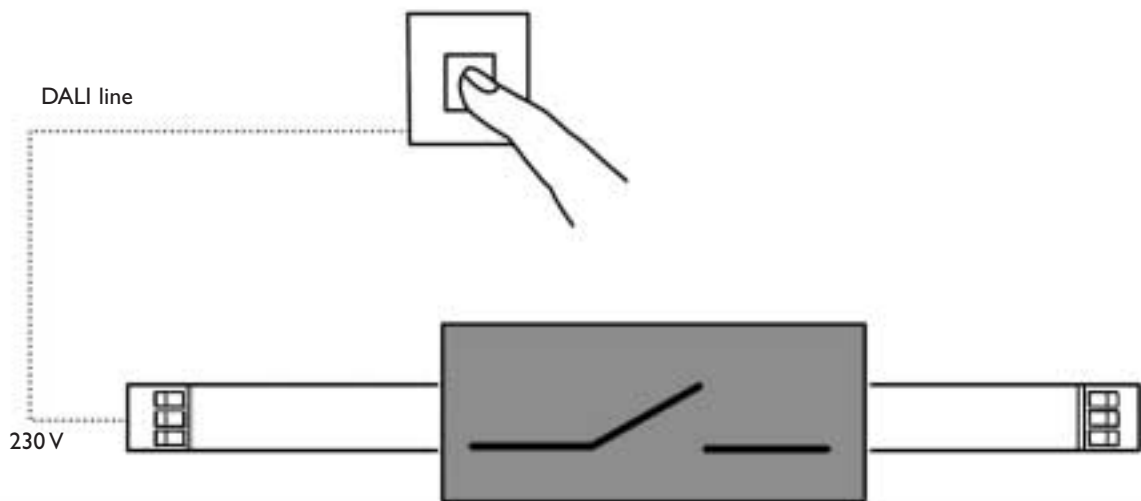

Figure 3

The fact that the 230 V supply voltage is permanently connected results in a power loss in each electronic ballast. This is negligible, however, when compared to the potential energy savings of the system considered as a whole.

2.5. Addressability

Up to 64 addresses can be assigned in a DALI system. This means that 64 different electronic ballasts can be controlled independently of each other. Addressing must be performed after the system has been installed. The addressing procedure is depended by the controller.

2.6. Light groups

The addressed ballasts or luminaires can be combined into light groups. Up to 16 groups are possible for each DALI line.

2.7. Simple installation

No special wiring such as twisted pairs or special cables are required for installing a DALI line. Twin control wires in existing installations can also be used as DALI lines. 'Free installation'

A DALI system can be installed as shown in the next drawing, though it is important to ensure that the maximum voltage drop does not exceed 2V.

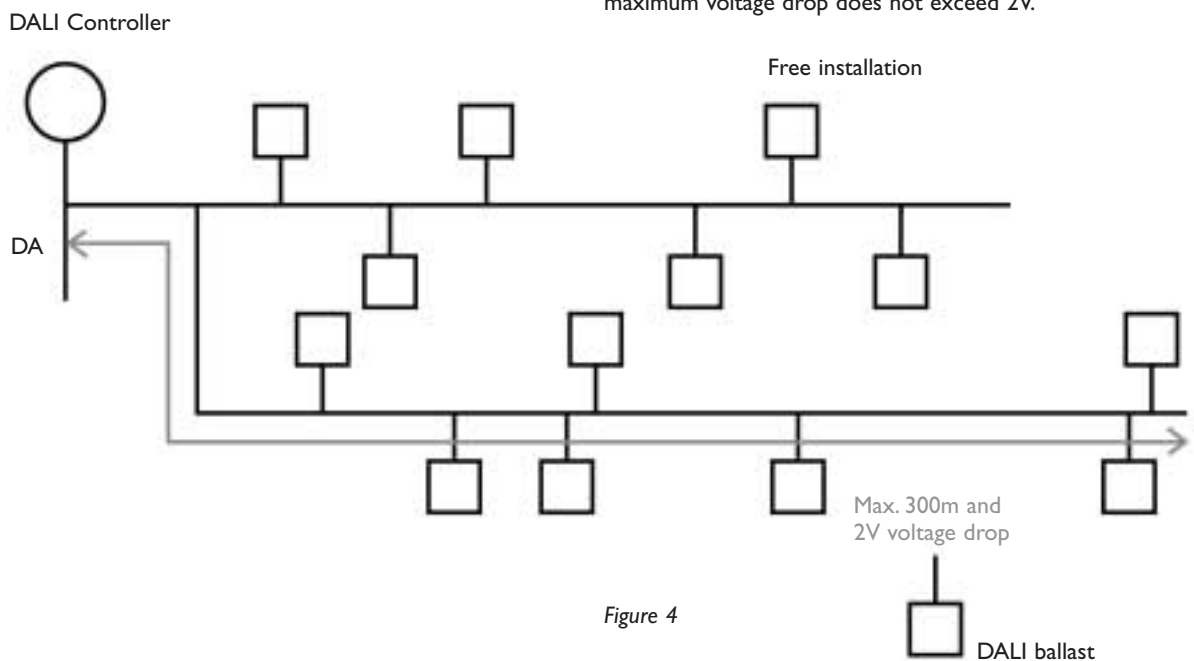

Figure 4

2.8. Characteristics of DALI

Planning

- DALI allows subsequent functional adaptation by the control units

Installation

- Existing 5-pole cables can be used
- DALI means fewer control units and therefore less wiring; this in turn means lower total costs.

Programming

- The programming feature offers new opportunities for installers.

DALI system

3.1. System description

TRIOS DALI is a room lighting controller. It can be used for the following functions:

- Daylight-controlled light regulation
- Movement-controlled switching
- Manual dimming via switches or IR remote control

These functions can be set by means of the IRT 1090 remote programming control, used in conjunction with an appropriate sensor. Up to 5 independent light groups can be programmed.

The TRIOS DALI controller is accommodated in a surface-mounted housing to which up to 20 electronic DALI ballasts can be connected via the DALI line.

The system power of the individual DALI ballasts and groups of ballasts can be disregarded.

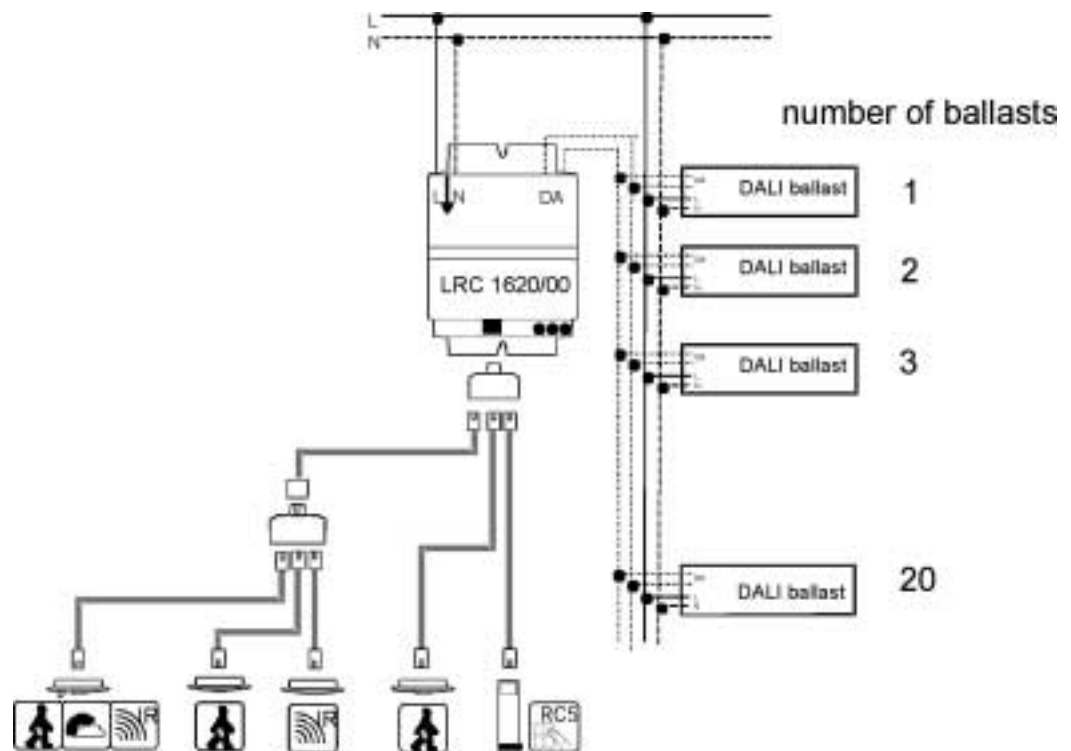

Figure 5

3.2. Switch and sensor lines

Switches are to be connected using conventional installation material for extra-low voltages

(e.g. U 72 1x4x0.5). Pre-connectorised cable material is available for sensors and is described in detail below.

If longer cables need to be installed or tubes are used, a cable of type U 72 1x4x0.5 can be employed. If long cable runs are needed it is advisable to use shielded cable.

3.2.1 Structure



Pin	Colour	Function
1	white	+12V Supply voltage for light- and movement sensor
2	black	0V Ground
3	red	+5V Supply voltage for IR sensor
4	green	Light sensor
5	yellow	IR sensor, push-button interface
6	blue	Movement sensor

Figure 6: Structure of the sensor line

3.2.2 Sensor line lengths to suit practical needs

Sensor lines suitable for longer distances can be created by plugging together pre-connectorised cables.

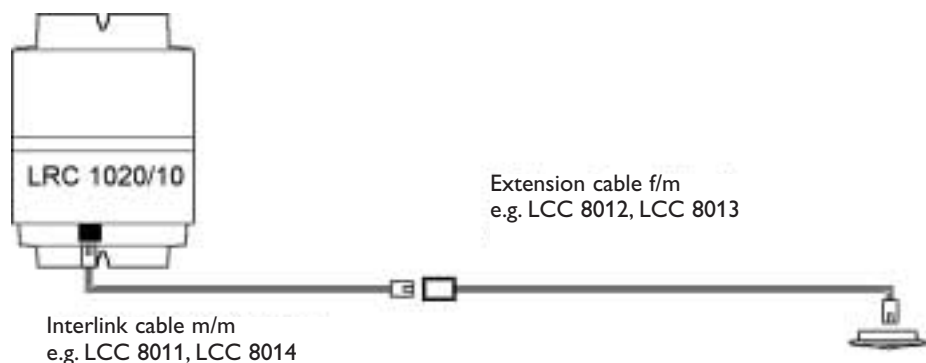

Figure 7: The required cable length is obtained by adding pre-connectorised extension cables.

The following pre-connectorised cables are available:

	Designation	Length
Plug/plug	LCC 8011	1 m
	LCC 8014	5 m
Plug/socket	LCC 8012	5 m
	LCC 8013	20 m
Branching connector	LCC 8024	3f/1m

3.2.3 Maximum line lengths

Connection between sensor and TRIOS DALI 30 m
 Total length of all sensor lines connected to a TRIOS DALI 125 m

Performance can be impaired if these line lengths are exceeded. If greater distances need to be spanned in individual cases, it is advisable to use shielded cables.

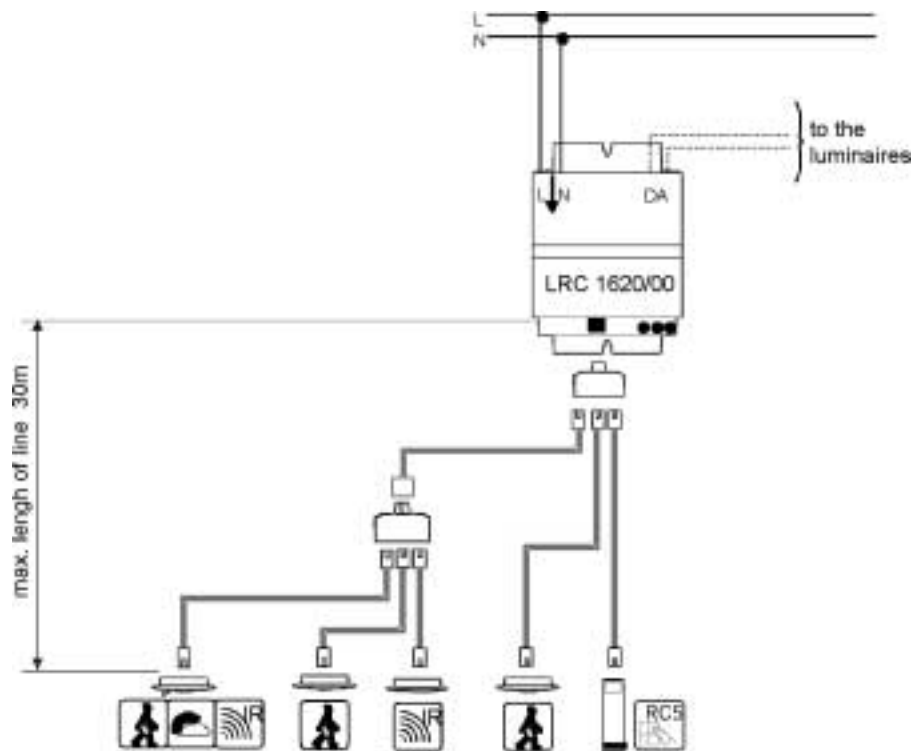

Figure 8

For details about the push-button interface, refer to the section " 7.3.6. Push-button interface".

Applications / Overview

4.1. Routing

The diagram below facilitates the precise identification of the functional requirements which must be met by a lighting installation and the layout of the necessary DALI components

Is a movement sensor used? **YES**

Is a light sensor used? **YES**

Is a remote control used? **YES**

Is regulation via switches? **YES**





Is a switch used for switching? **YES**

						Number of individual light groups	Page	Section
Sensors	O/I 230V							
DALI solutions								
Manual switching and regulation								
Switch module and switch		x				1	16	5.1

This page provides a description of the application.





4.2. Overview: Which function with which sensors, no programming

DALI supports different modes of operation, depending on the application. The TRIOS unit recognises which sensors are connected and automatically adapts to these. The following table provides an overview of these functionalities and the related sensor combination. No programming is required for these applications. The parameters can only be adjusted on the sensors.

						Number of individual light groups	Page	Section
Sensors	O/I 230V							
DALI solutions without programming								
<i>Manual switching and regulation</i>								
Switch module and switch		x				1	17	5.1
Infrared remote control			x			1	18	5.2
Infrared remote control, switch module and switch		x	x			1	19	5.3
<i>Daylight-controlled light regulation</i>								
Automatic				x		1	20	5.4
With manual control, switch 230V	x			x		1	21	5.5
With manual control, switch module and switch		x		x		1	22	5.6
With infrared remote control			x	x		1	23	5.7
<i>Movement-controlled switching</i>								
Fully automatic					x	1	24	5.8
With manual control, switch 230V	x				x	1	25	5.9
With manual control, switch module and switch		x			x	1	26	5.10
With infrared remote control			x		x	1	27	5.11
<i>Daylight-controlled and movement-controlled switching together</i>								
Fully automatic				x	x	1	28	5.12
With manual control, switch 230V	x			x	x	1	29	5.13
With manual control, switch module and switch		x		x	x	1	30	5.14
With infrared remote control			x	x	x	1	31	5.15
With manual control, infrared remote control, switch module and switch		x	x	x	x	1	32	5.16

4.3. Overview: Which function with which sensors, with programming

DALI supports different modes of operation, depending on the application. The TRIOS unit recognises which sensors are connected and automatically adapts to these. The following table provides an overview of these functionalities and the related sensor combination.

						Number of individual light groups	Page	Section
Sensors	O/I 230V							
DALI solutions with programming								
<i>Manual switching and regulation</i>								
Switch module		x				1-5	33	6.1
Infrared remote control			x			1-5	34	6.2
Infrared remote control, switch module and switch		x	x			1-5	35	6.3
<i>Daylight-controlled regulation</i>								
Fully automatic				x		2	36	6.4
With manual control, switch 230V	x			x		2	37	6.5
With manual control, switch module and switch		x		x		2	38	6.6
With infrared remote control			x	x		2	39	6.7
<i>Movement-controlled switching</i>								
With manual control, switch module and switch		x			x	1-5	40	6.8
With infrared remote control			x		x	1-5	41	6.9
<i>Daylight-controlled and movement-controlled switching together</i>								
Fully automatic				x	x	1-5	42	6.10
With manual control, switch 230V	x			x	x	1-5	43	6.11
With manual control, switch module and switch		x		x	x	1-5	44	6.12
With infrared remote control			x	x	x	1-5	45	6.13
With manual control, infrared remote control, switch module and switch		x	x	x	x	1-5	46	6.14

4.4. Explanation of symbols

Switch 230V		
IR receiver		Movement sensor
Light sensor		Switch module
By hand		Absent
Bright		Present
Dark		IR remote control
Medium brightness		

The examples in sections 5 and 6 contain symbols for a brief description of the relevant control and regulation pattern.

Manual control



Switch 230V



Switching and dimming using a push-button panel + RC5 interface



Switching and dimming by IR remote control

Daylight-controlled light regulation



Switches on if the daylight falls below the required value



Artificial light is adjusted in line with daylight conditions



Switches off if the level of daylight is more than 1.5 x the required value for longer than 15 minutes

Setting the required value for daylight-controlled light regulation using:



RC5 interface + push button panel



IR remote control



Light sensor adjustment

Movement-controlled light



Switches on if movement is recorded



Switches off if no movement is recorded; switch-off can be delayed for up to 45 minutes





Applications without programming

5.1. Manual switching and regulation, push-button interface and push-button

Application

Choice of dimming and switching functions and / or up to four light scenes via conventional switches, suitable for conference rooms.



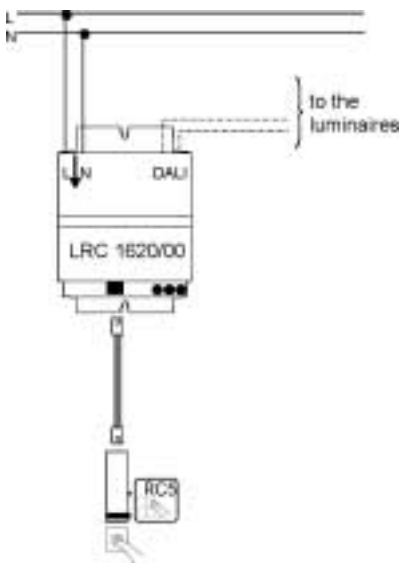

Function

Switch on	Switch off	Dim	Scenes	Circuit
				1

Circuit diagram



Parts list

	Quantity	Type
	1	TRIOS DALI LRC 1620 Surface-mounted version DALI control unit
		Any pulse-operated switch from others
	1	Push-button Interface LCU 8020
	1	Sensor line LCC 8014 5m plug/plug LCC 8011 1m plug/plug

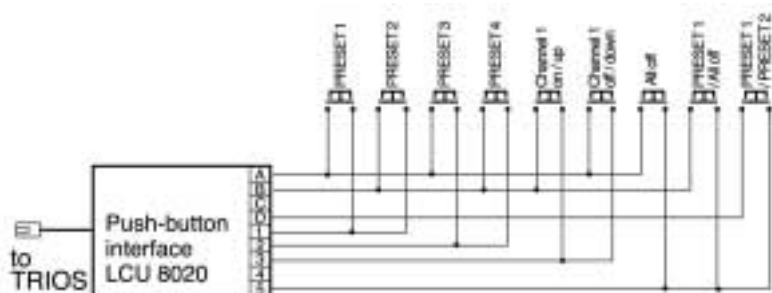

Default

IR: Group A, Channel 1 / PRESET: P1= 100%, P2= 50%, P3= 25%, P4= 10%
Switch on with 230V switch not possible.

5.2. Manual switching and regulation, infrared control

Application

Rooms where no vertical wiring is possible, especially attractive with flexible room plans or conference rooms.



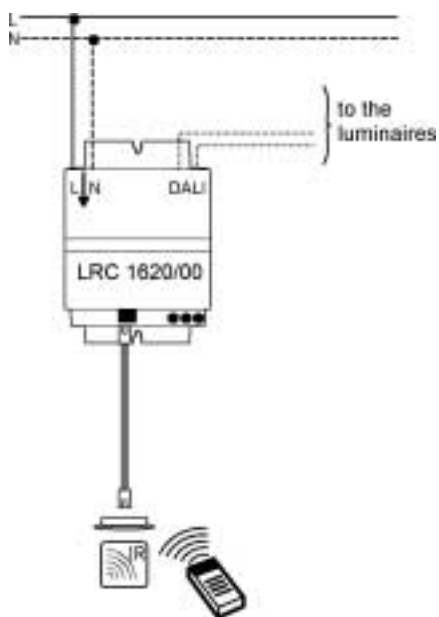

Function

Switch on	Switch off	Dim	Scenes	Circuit
				1

Circuit diagram



Parts list

	Quantity	Type
	1	TRIOS DALI LRC 1620 Surface-mounted version DALI control unit
	1	IR sensor IRR 8124 IRR 8125
	Any number	IR remote control IRC 2130 - 5 channels, 4 scenes IRT 8050 - 2 switches
	1	Sensor line LCC 8014 5m plug/plug LCC 8012 5m plug/sckt.

Default





IR: Group A, Channel 1 / PRESET: P1= 100%, P2= 50%, P3= 25%, P4= 10%
Switch on with 230V switch not possible.

5.3. Manual switching and regulation, infrared control, push-button interface and switch

Application

Rooms requiring simple, flexible lighting control from fixed and mobile points; e.g. conference rooms





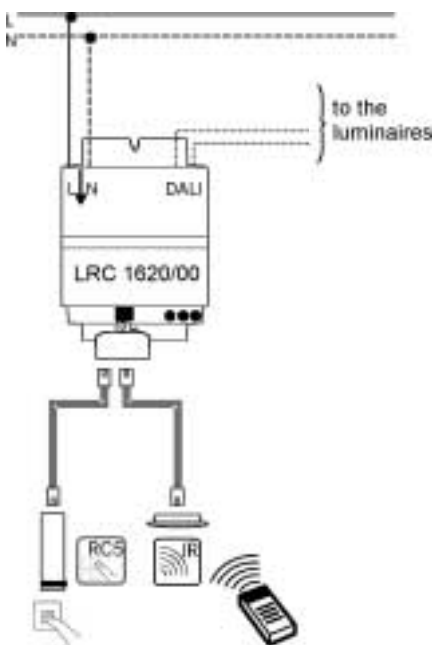

Function

Switch on	Switch off	Dim	Scenes	Circuit
				1

Circuit diagram



Parts list

	Quantity	Type
	1	TRIOS DALI LRC 1620 Surface-mounted version DALI control unit
	1	IR sensor IRR 8124 IRR 2125
	Any number	IR remote control IRC 2130 - 5 channels, 4 scenes IRT 8050 - 2 switches
		Any pulse-operated switch from others
	1	LCU 8020 switch module
	1	LCC 8024 Branching connector 1m/3f
	2	Sensor line LCC 8014 5m plug/plug LCC 8012 5m plug/socket

Default





IR: Group A, Channel 1 / PRESET: P1= 100%, P2= 50%, P3= 25%, P4= 10%
Switch on with 230V switch not possible.

5.4. Daylight-controlled light regulation, automatic

Application

Power savings through daylight use, with automatic reactivation. Is used in offices or factories with central control systems.

Function

	Switch on	Switch off	Dim	Circuit	Nominal value setting
Manual					
Automatic				1	
	at min light level	at 150% of ref. light level			





TRIOS DALI automatically switches on the lighting installation at dusk.

A central switch, or switch installed in the circuit before the TRIOS control unit is required to deactivate the system outside office hours.

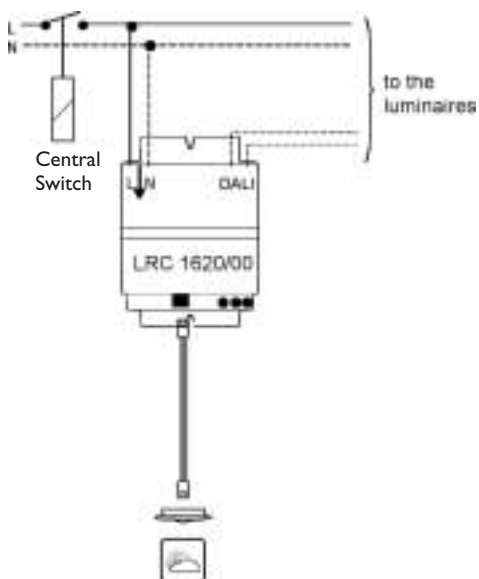
Circuit diagram



Parts list

	Quantity	Type
	1	TRIOS DALI LRC 1620 Surface-mounted version DALI control unit
	1	Daylight sensor LRL 8101
	1	Sensor line LCC 8014 5m plug/plug

5.5. Daylight-controlled light regulation, with manual control, switch 230V

Application

Energy saving through daylight use, with automatic reactivation. Is used in offices or factories with central control systems.

Function

	Switch on	Switch off	Dim	Circuit	Nominal value setting
Manual				1	
Automatic				1	
	at min light level	at 150% of ref. light level			



TRIOS DALI automatically switches on the lighting installation at dusk.

A central switch, or switch installed in the circuit before the TRIOS control unit is required to deactivate the system outside office hours.

Circuit diagram

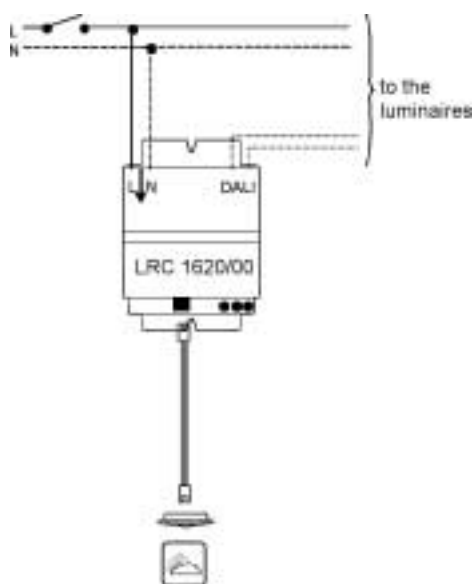

Parts list









	Quantity	Type
	1	TRIOS DALI LRC 1620 Surface-mounted version DALI control unit
	1	Daylight sensor LRL 8101
	1	Sensor line LCC 8014 5m plug/plug

5.6. Daylight-controlled light regulation, with manual control, switch module and switch

Application

Conference rooms, auditoria and rooms with some daylight, where lighting conditions need to be matched to momentary requirements and energy saved.

Function





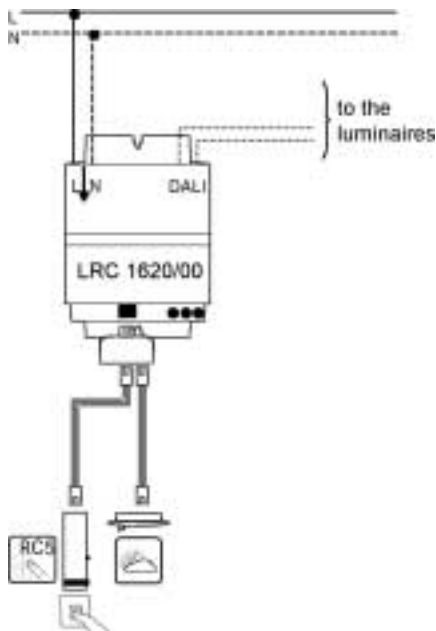

	Switch on	Switch off	Dim	Circuit	Nominal value setting
Manual	 	 		1	 
Automatic				1	
	at PRESET 1	at 150% of ref. light level			

TRIOS DALI switches off the lighting installation when there is sufficient natural light. It can only be switched on manually. This prevents the system from switching on again unnoticed after staff have left.

Circuit diagram



Parts list

	Quantity	Type
	1	TRIOS DALI LRC 1620 Surface-mounted version DALI control unit
		Any pulse-operated switch from others
	1	Daylight sensor LRL 8101
	1	Switch module LCU 8020
	1	Branching connector 1m/3f LCC 8024
	2	Sensor line LCC 8014 5m plug/plug

Default

IR: Group A, Channel 1 / PRESET: P1= 100%, P2= 50%, P3= 25%, P4= 10%
No daylight control: P2, P3, P4







5.

5.7. Daylight-controlled light regulation, with infrared remote control

Application

This solution provides flexible lighting and the ability to regulate dependent on daylight conditions, and is therefore ideal for modern offices. It is also suitable for renovations, since no wall switches need to be installed.

Function



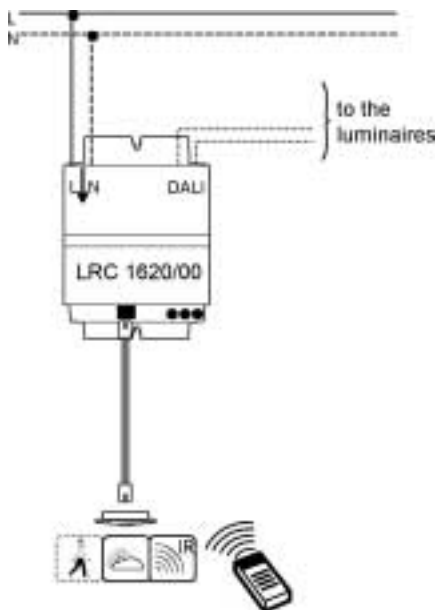

	Switch on	Switch off	Dim	Circuit	Nominal value setting
Manual				1	
Automatic				1	
	at PRESET 1	at 150% of ref. light level			

TRIOS DALI switches off the lighting installation when there is sufficient natural light. It can only be switched on manually. This prevents the system from switching on again unnoticed after staff have left. Convenient IR remote control for easy setting of required values.

Circuit diagram



Parts list

	Quantity	Type
	1	TRIOS DALI LRC 1620 Surface-mounted version DALI control unit
	1	Multisensor LRI 8133
	Any number	IR remote control, e.g.: IRC 2130 - 5 channels, 4 scenes IRT 8050 - 2 switches
	1	Sensor line LCC 8014 5m plug/plug

Default



IR: Group A, Channel 1 / PRESET: P1= 100%, P2= 50%, P3= 25%, P4= 10%
No daylight control: P2, P3, P4

5.8. Movement-controlled lighting, fully automatic

Application

Conference rooms and corridors where light is switched on and off automatically according to occupancy.

Function

	Switch on	Switch off	Circuit
Manual			1
Automatic			1



at PRESET 1

TRIOS switches the light on / off after the last detected movement. The interval between the last movement and deactivation of the light can be set on the sensor for up to 45 minutes.

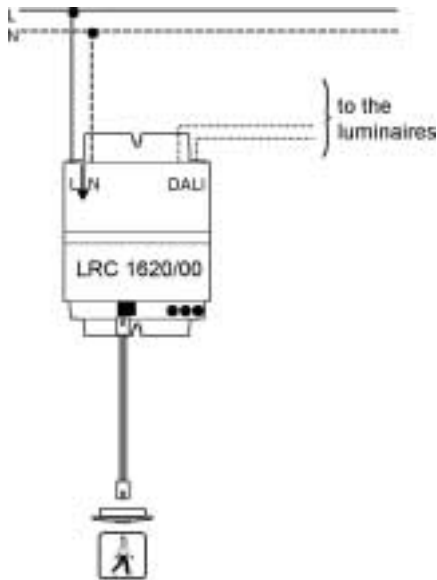
Circuit diagram



Parts list





	Quantity	Type
	1	TRIOS DALI LRC 1620 Surface-mounted version DALI control unit
	1	Movement sensor LRM 8112 LRM 8115
	1	Sensor line LCC 8014 5m plug/plug

5.9. Movement-controlled lighting, with manual control, switch 230V

Application

Conference rooms and corridors where light is switched on and off automatically according to occupancy. Possibility of manual override.

Function

	Switch on	Switch off	Circuit
Manual			1
Automatic			1



at PRESET 1

TRIOS switches the light on / off after the last detected movement. The interval between the last movement and deactivation of the light can be set on the sensor for up to 45 minutes.

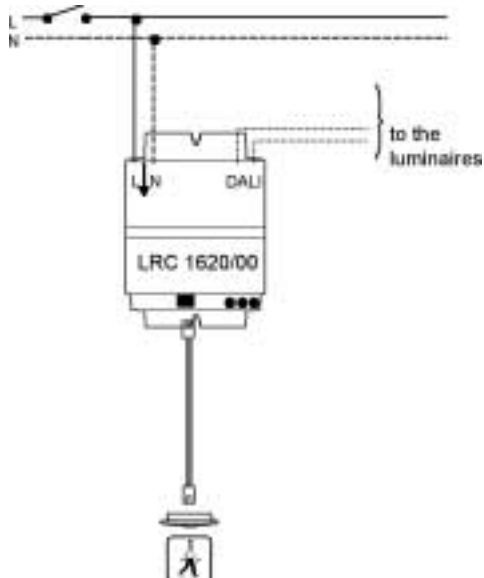
Circuit diagram



Parts list





	Quantity	Type
	1	TRIOS DALI LRC 1620 Surface-mounted version DALI control unit
	1	Movement sensor LRM 8112 LRM 8115
	1	Sensor line LCC 8014 5m plug/plug

5.10. Movement-controlled lighting, with manual control, switch module and switch

Application

Exhibition rooms where different ambiances are required. The lighting is automatically switched off when the room is unoccupied.

Function





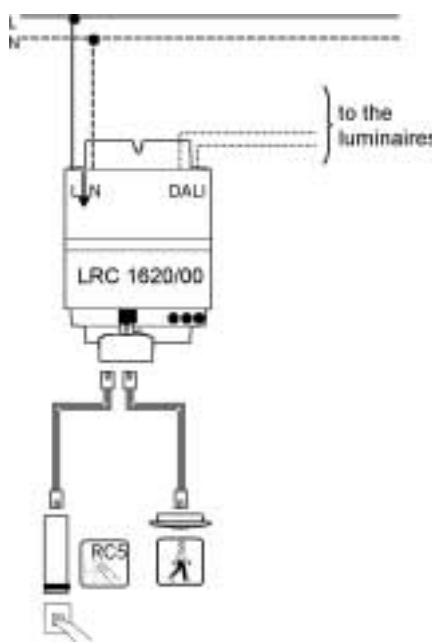

	Switch on	Switch off	Dim	Scenes	Circuit
Manual					1
Automatic					1

at PRESET

Circuit diagram



Parts list

	Quantity	Type
	1	TRIOS DALI LRC 1620 Surface-mounted version DALI control unit
		Any pulse-operated switch from others
	1	Switch module LCU 8020
	1	Movement sensor LRM 8112 LRM 8115
	1	Branching connector 1m/3f LCC 8024
	1	Sensor line LCC 8014 5m plug/plug

Default





IR: Group A, Channel 1 / PRESET: P1= 100%, P2= 50%, P3= 25%, P4= 10%
No daylight control: P2, P3, P4

5.11. Movement-controlled lighting, with infrared remote control

Application

Modern workplaces. The light is adjusted automatically in accordance with daylight conditions and the user's needs.

Function



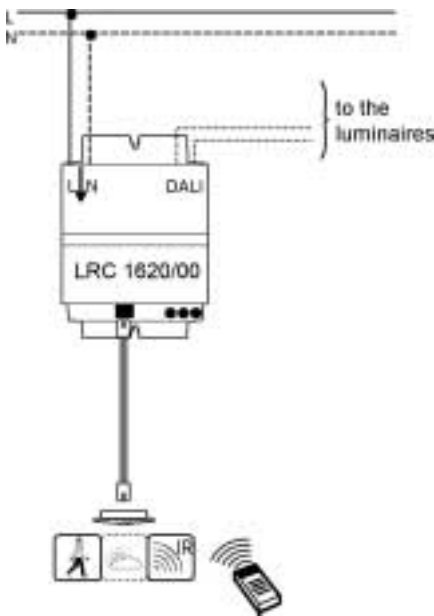

	Switch on	Switch off	Dim	Scenes	Circuit
Manual					1
Automatic					1

at PRESET

Circuit diagram



Parts list

	Quantity	Type
	1	TRIOS DALI LRC 1620 Surface-mounted version DALI control unit
 	1	Multisensor LRI 8133
	Any number	IR remote control IRC 2130 - 5 channels, 4 scenes IRT 8050 - 2 switches
	1	Sensor line LCC 8014 5m plug/plug

Default







IR: Group A, Channel 1 / PRESET: P1= 100%, P2= 50%, P3= 25%, P4= 10%
No daylight control: P2, P3, P4

5.12. Daylight regulation and movement-controlled lighting, fully automatic

Application

Modern workplaces. The light is adjusted automatically in accordance with daylight conditions and the user's needs.

Function





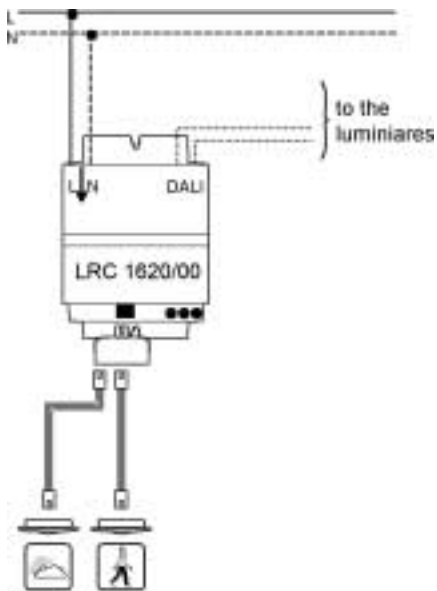

	Switch on	Switch off	Dim	Circuit	Nominal value setting
Manual					
Automatic	 	 		1	
	at PRESET 1	at 150% of ref. light level			

TRIOS DALI switches on the lighting automatically when a movement is detected provided that natural light is insufficient. The lighting is switched off automatically when the natural light is adequate and / or the room is unoccupied.

Circuit diagram



Parts list

	Quantity	Type
	1	TRIOS DALI LRC 1620 Surface-mounted version DALI control unit
	1	Daylight sensor LRL 8101
	1	Movement sensor LRM 8112 LRM 8115
 	or 1	Multisensor LRI 8133 Alternative product for LRM and LRL
	1	Branching connector 1m/3f LCC 8024
	1	Sensor line LCC 8014 5m plug/plug

5.13. Daylight regulation and movement-controlled lighting, switch 230V

Application

Modern workplaces. The light is adjusted automatically in accordance with daylight conditions and the user's needs.

Function

	Switch on	Switch off	Dim	Circuit	Nominal value setting
Manual					
Automatic				1	
	at PRESET 1	at 150% of ref. light level			

Circuit diagram

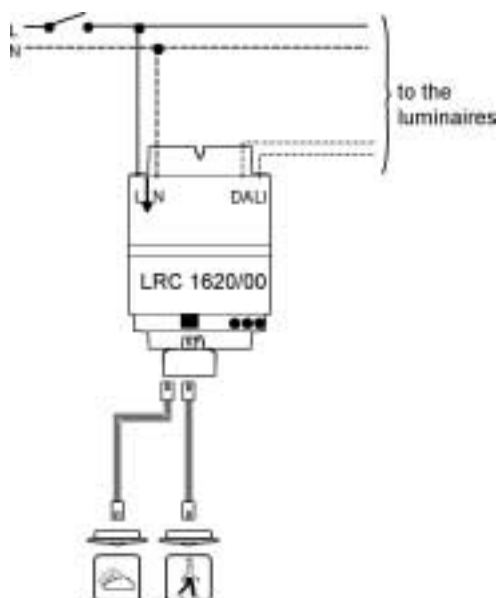

Parts list









	Quantity	Type
	1	TRIOS DALI LRC 1620 Surface-mounted version DALI control unit
	1	Daylight sensor LRL 8101
	1	Movement sensor LRM 8112 LRM 8115
	or 1	Multisensor LRI 8133 Alternative product for LRM and LRL
	1	Branching connector 1m/3f LCC 8024
	1	Sensor line LCC 8014 5m plug/plug

5.14. Daylight regulation and movement-controlled lighting, with manual control, switch module and switch

Application

Rooms where the lighting must be regulated manually in accordance with daylight conditions and the light needs to be switched off automatically, e.g. conference rooms with some daylight.





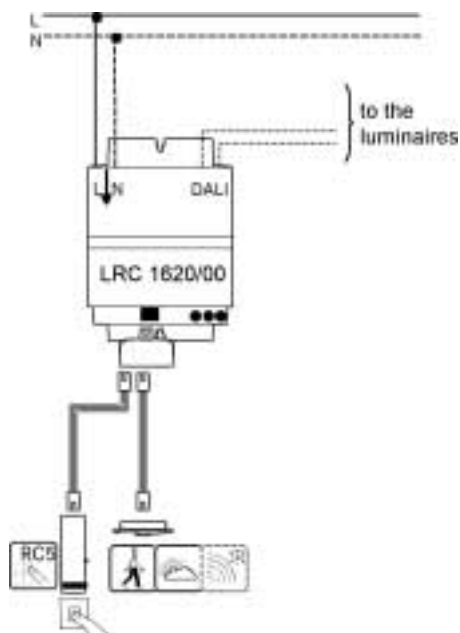

Function

	Switch on	Switch off	Dim	Circuit	Nominal value setting
Manual				1	 
Automatic		 		1	
	at PRESET 1	at 150% of ref. light level			

Circuit diagram

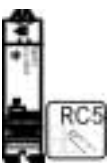

Parts list

	Quantity	Type
	1	TRIOS DALI LRC 1620 Surface-mounted version DALI control unit
		Any pulse-operated switch from others
 	1	Multisensor LRI 8133
	1	Switch module LCU 8020
	1	Branching connector 1m/3f LCC 8024
	2	Sensor line LCC 8014 5m plug/plug

Default









IR: Group A, Channel 1 / PRESET: P1= 100%, P2= 50%, P3= 25%, P4= 10%
No daylight control: P2, P3, P4

5.15. Daylight regulation and movement-controlled lighting, with manual control, infrared remote control

Application

Suitable for modern and multi-functional lighting systems where the user wishes to adjust the lighting conditions from his workplace.





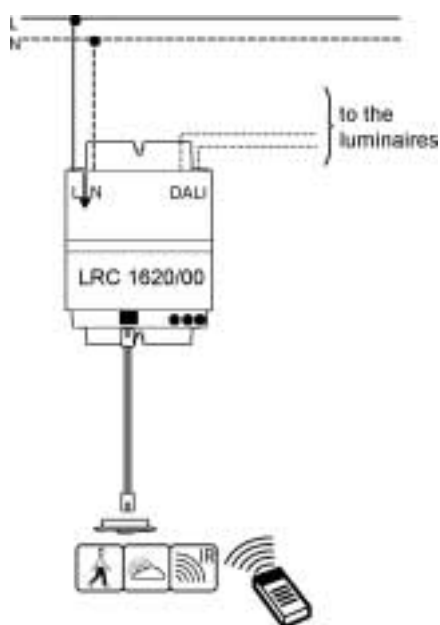

Function

	Switch on	Switch off	Dim	Circuit	Nominal value setting
Manual				1	 
Automatic		 		1	
	at PRESET 1	at 150% of ref. light level			

Circuit diagram



Parts list

	Quantity	Type
	1	TRIOS DALI LRC 1620 Surface-mounted version
		DALI control unit
  	1	Multisensor LRI 8133
	Any number	IR remote control, e.g.: IRC 2130 - 5 channels, 4 scenes IRT 8050 - 2 switches
	1	Sensor line LCC 8014 5m plug/plug

Default







IR: Group A, Channel 1 / PRESET: P1= 100%, P2= 50%, P3= 25%, P4= 10%
No daylight control: P2, P3, P4

5.16. Daylight regulation and movement-controlled lighting, with manual control, infrared remote control and push-button interface

Application

Suitable for modern and multi-functional lighting systems where the user wishes to adjust the lighting conditions from his workplace.

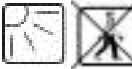



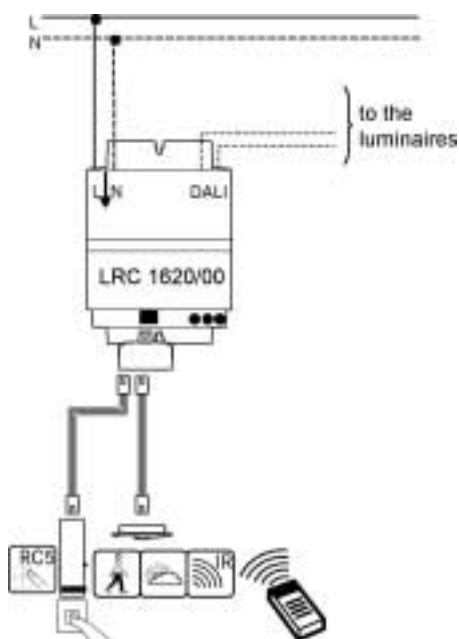

Function

	Switch on	Switch off	Dim	Circuit	Nominal value setting
Manual				1	
Automatic				1	
	at PRESET 1	at 150% of ref. light level			

Circuit diagram

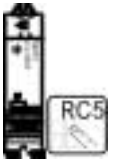

Parts list

	Quantity	Type
	1	TRIOS DALI LRC 1620 Surface-mounted version DALI control unit
	1	Multisensor LRI 8133
	1	Switch module LCU 8020
	1	Branching connector 1m/3f LCC 8024
	Any number	IR remote control, e.g.: IRC 2130 - 5 channels, 4 scenes IRT 8050 - 2 switches
	1	Sensor line LCC 8014 5m plug/plug

Default

IR: Group A, Channel 1 / PRESET: P1= 100%, P2= 50%, P3= 25%, P4= 10%
No daylight control: P2, P3, P4





Applications with programming

6.1. Manual switching and regulation, push-button interface and push-button

Application

Selecting dimming, switching and / or up to four light scenes via conventional switches: suitable for conference rooms.



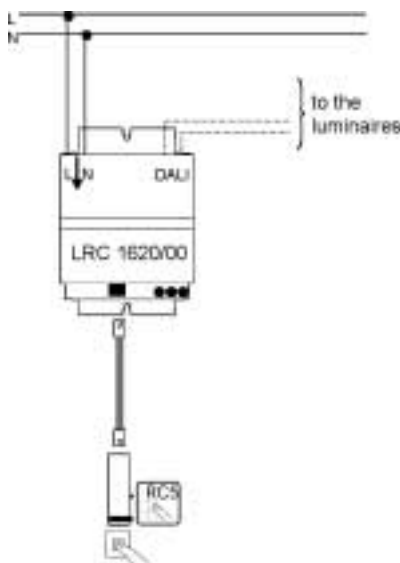

Function

Switch on	Switch off	Dim	Scenes	Circuits
				2-5

Circuit diagram



Parts list

	Quantity	Type
	1	TRIOS DALI LRC 1620 Surface-mounted version DALI control unit
		Any pulse-operated switch
	1	Push-button Interface LCU 8020
	1	Sensor line LCC 8014 5m plug/plug LCC 8011 1m plug/plug

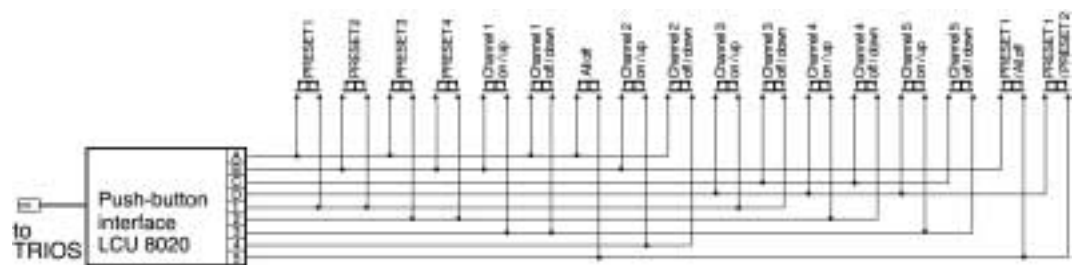

Programming

See chapter on programming – Programming will require the temporary connection of an IR receiver IRR 8125 and a programming transmitter IRT 1090

6.2. Manual switching and regulation, infrared control

Application

Rooms where no vertical wiring is possible, especially attractive with flexible room plans or conference rooms.



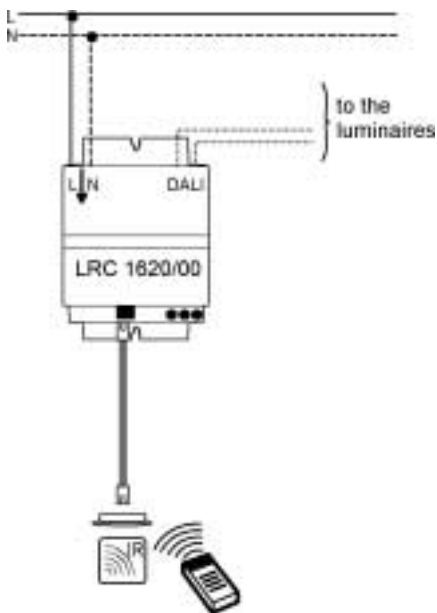

Function

Switch on	Switch off	Dim	Scenes	Circuits
				2-5

Circuit diagram



Parts list

	Quantity	Type
	1	TRIOS DALI LRC 1620 Surface-mounted version DALI control unit
	1	IR sensor IRR 8124 IRR 8125
	Any number	IR remote control IRC 2130 - 5 channels, 4 scenes IRT 8050 - 2 switches
	1	Sensor line LCC 8014 5m plug/plug LCC 8012 5m plug/sckt.

Programming

See chapter on programming

Switch on with 230V switch not possible.









– Programming will require the temporary connection of a programming transmitter IRT 1090

6.3. Manual switching and regulation, infrared control, push-button interface and switch

Application

In conference rooms where the light needs to be location-specific (entrance) and flexible.





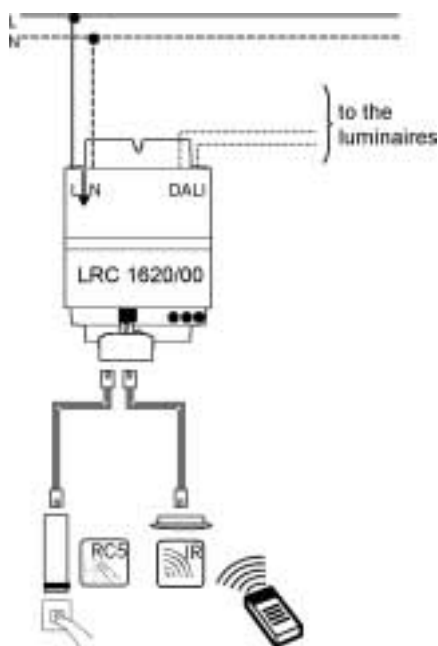

Function

Switch on	Switch off	Dim	Scenes	Circuits
 	 	 	 	2-5

Circuit diagram

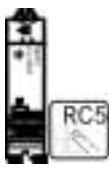

Parts list

	Quantity	Type
	1	TRIOS DALI LRC 1620 Surface-mounted version DALI control unit
	1	IR sensor IRR 8124 IRR 2125
	Any number	IR remote control IRC 2130 - 5 channels, 4 scenes IRT 8050 - 2 switches
		Any pulse-operated switch
	1	LCU 8020 switch module
	1	LCC 8024 Branching connector
	2	Sensor line LCC 8014 5m plug/plug LCC 8012 5m plug/socket

Programming

See chapter on programming





Switch on with 230V switch not possible. – Programming will require the temporary connection of a programming transmitter IRT 1090

6.4. Daylight-controlled light regulation, automatic

Application

Energy saving through daylight use, with automatic reactivation. Is used in offices or factories with central control systems.

Function

	Switch on	Switch off	Dim	Circuits	Nominal value setting
Manual				1	
Automatic				2	
	at min light level	at 150% of ref. light level			





TRIOS DALI automatically switches on the lighting installation at dusk.

A central switch, or switch installed in the circuit before the TRIOS control unit is required to deactivate the system outside office hours.

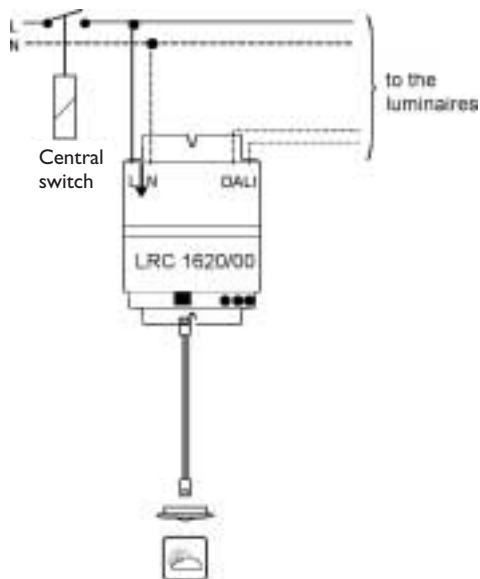
Circuit diagram



Parts list

	Quantity	Type
	1	TRIOS DALI LRC 1620 Surface-mounted version DALI control unit
	1	Daylight sensor LRL 8101
	1	Sensor line LCC 8014 5m plug/plug

Programming

See chapter on programming and notes on daylight-controlled light regulation – Programming will require the temporary connection of an IR receiver IRR 8125 and a programming transmitter IRT 1090

6.5. Daylight-controlled light regulation, with manual control, switch 230V

Application

Energy saving through daylight use, with automatic reactivation. Is used in offices or factories with central control systems.

Function

	Switch on	Switch off	Dim	Circuits	Nominal value setting
Manual				1	
Automatic				2	
	at min light level	at 150% of ref. light level			



TRIOS DALI automatically switches on the lighting installation at dusk.

A central switch, or switch installed in the circuit before the TRIOS control unit is required to deactivate the system outside office hours

Circuit diagram

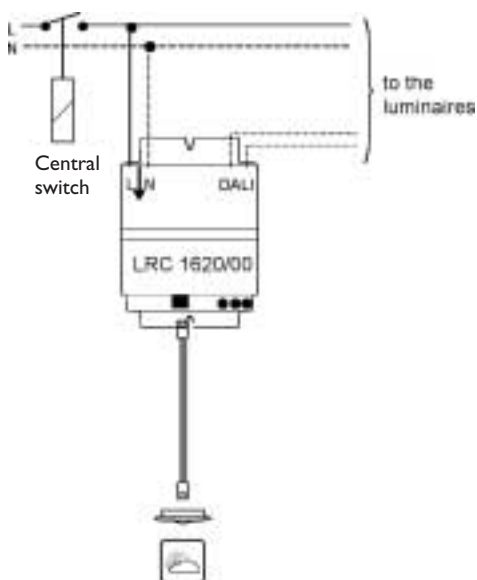

Parts list

	Quantity	Type
	1	TRIOS DALI LRC 1620 Surface-mounted version DALI control unit
	1	Daylight sensor LRL 8101
	1	Sensor line LCC 8014 5m plug/plug

Programming







See chapter on programming and notes on daylight-controlled light regulation – Programming will require the temporary connection of an IR receiver IRR 8125 and a programming transmitter IRT 1090

6.6. Daylight-controlled light regulation, with manual control, switch module and switch

Application

Conference rooms, auditoria and rooms with some daylight, where lighting conditions need to be matched to momentary requirements and energy saved.

Function





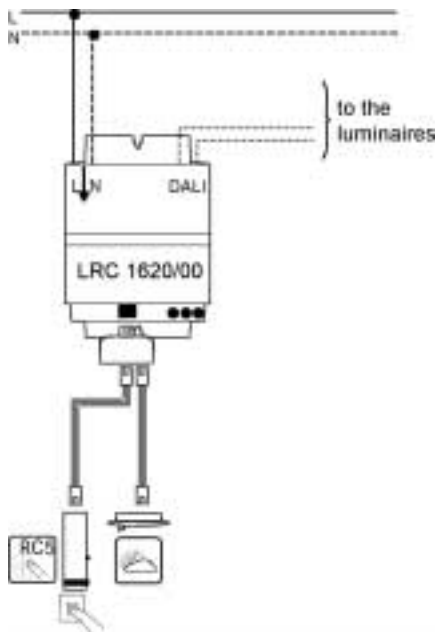

	Switch on	Switch off	Dim	Circuits	Nominal value setting
Manual				2-5	
Automatic				2	
	at PRESET 1	at 150% of ref. light level			

TRIOS DALI switches off the lighting installation when there is sufficient natural light. It can only be switched on manually. This prevents the system from switching on again unnoticed after staff have left.

Circuit diagram



Parts list

	Quantity	Type
	1	TRIOS DALI LRC 1620 Surface-mounted version DALI control unit
		Any pulse-operated switch
	1	Daylight sensor LRL 8101
	1	Switch module LCU 8020
	1	Branching connector LCC 8024
	2	Sensor line LCC 8014 5m plug/plug

Programming







See chapter on programming and notes on daylight-controlled light regulation – Programming will require the temporary connection of an IR receiver IRR 8125 and a programming transmitter IRT 1090

6.7. Daylight-controlled light regulation, with infrared remote control

Application

This solution provides flexible lighting and the ability to regulate dependent on daylight conditions, and is therefore ideal for modern offices. It is also suitable for renovations, since no switches need to be installed.

Function



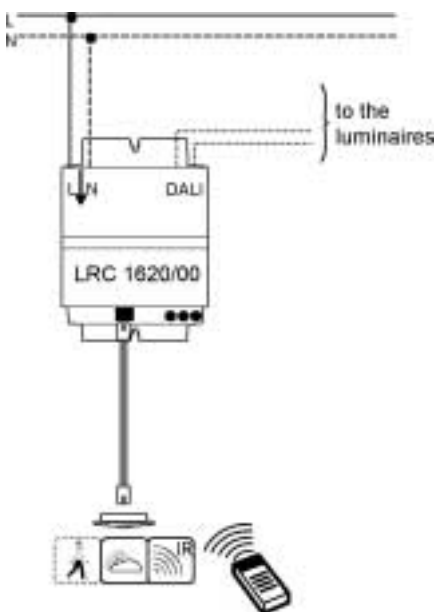

	Switch on	Switch off	Dim	Circuits	Nominal value setting
Manual				2-5	
Automatic				2	
	at PRESET 1	at 150% of ref. light level			

TRIOS DALI switches off the lighting installation when there is sufficient natural light. It can only be switched on manually. This prevents the system from switching on again unnoticed after staff have left.

Circuit diagram



Parts list

	Quantity	Type
	1	TRIOS DALI LRC 1620 Surface-mounted version DALI control unit
	1	Multisensor LRI 8133
	Any number	IR remote control, e.g.: IRC 2130 - 5 channels, 4 scenes IRT 8050 - 2 switches
	1	Sensor line LCC 8014 5m plug/plug

Programming

See chapter on programming and notes on daylight-controlled light regulation





No daylight control: P2, P3, P4 – Programming will require the temporary connection of a programming transmitter IRT 1090

6.8. Movement-controlled lighting, with manual control, switch module and switch

Application

Exhibition rooms where different ambiances are required. The lighting is automatically switched off when the room is unoccupied.

Function





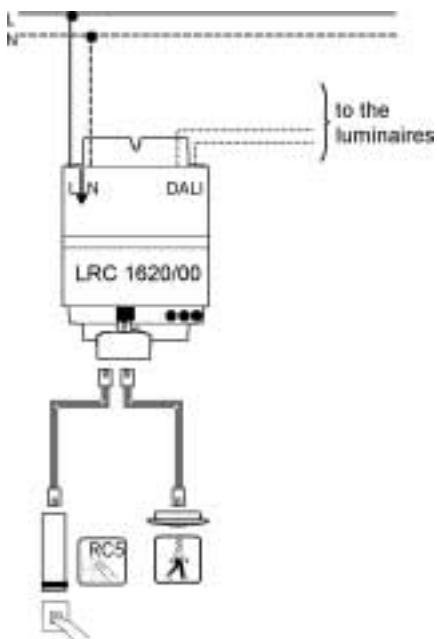

	Switch on	Switch off	Dim	Scenes	Circuits
Manual					2-5
Automatic					2-5

at PRESET

Circuit diagram



Parts list

	Quantity	Type
	1	TRIOS DALI LRC 1620 Surface-mounted version DALI control unit
		Any pulse-operated switch
	1	Switch module LCU 8020
	1	Movement sensor LRM 8112 LRM 8115
	1	Branching connector LCC 8024
	1	Sensor line LCC 8014 5m plug/plug

Programming





See chapter on programming and notes on daylight-controlled light regulation. No daylight control: P2, P3, P4 – Programming will require the temporary connection of an IR receiver IRR 8125 and a programming transmitter IRT 1090

6.9. Movement-controlled lighting, with infrared remote control

Application

Modern workplaces. The light is adjusted automatically in accordance with daylight conditions and the user's needs.

Function



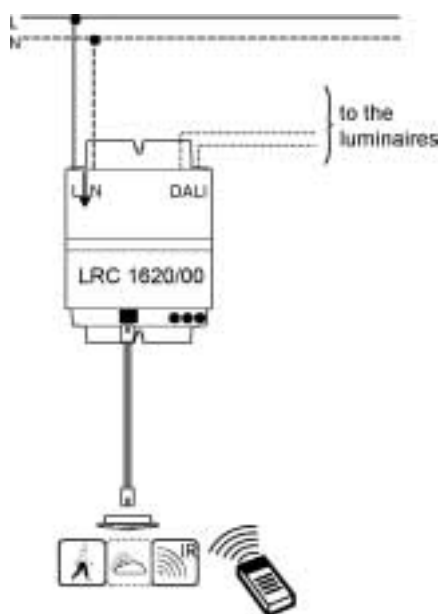

	Switch on	Switch off	Dim	Scenes	Circuits
Manual					2-5
Automatic					2-5

at PRESET

Circuit diagram



Parts list

	Quantity	Type
	1	TRIOS DALI LRC 1620 Surface-mounted version DALI control unit
 	1	Multisensor LRI 8133
	Any number	IR remote control IRC 2130 - 5 channels, 4 scenes IRT 8050 - 2 switches
	1	Sensor line LCC 8014 5m plug/plug

Programming





See chapter on programming – Programming will require the programming transmitter IRT 1090

6.10. Daylight regulation and movement-controlled lighting, fully automatic

Application

Modern workplaces. The light is adjusted automatically in accordance with daylight conditions and the user's needs.





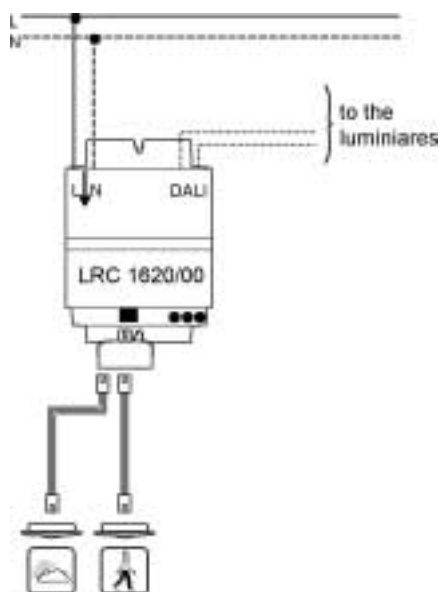

Function

	Switch on	Switch off	Dim	Circuits	Nominal value setting
Manual				1	
Automatic				2	
	at PRESET 1	at 150% of ref. light level			

Circuit diagram



Parts list

	Quantity	Type
	1	TRIOS DALI LRC 1620 Surface-mounted version DALI control unit
	1	Daylight sensor LRL 8101
	1	Movement sensor LRM 8112 LRM 8115
 	or 1	Multisensor LRI 8133 Alternative product for LRM and LRL
	1	Branching connector LCC 8024
	1	Sensor line LCC 8014 5m plug/plug

Programming

See chapter on programming and notes on daylight-controlled light regulation

No daylight control: P2, P3, P4 – Programming will require the temporary connection of an IR receiver IRR 8125 and a programming transmitter IRT 1090

6.11. Daylight regulation and movement-controlled lighting, switch 230V

Application

Modern workplaces. The light is adjusted automatically in accordance with daylight conditions and the user's needs.

Function

	Switch on	Switch off	Dim	Circuits	Nominal value setting
Manual				1	
Automatic				2	
	at PRESET 1	at 150% of ref. light level			

Circuit diagram

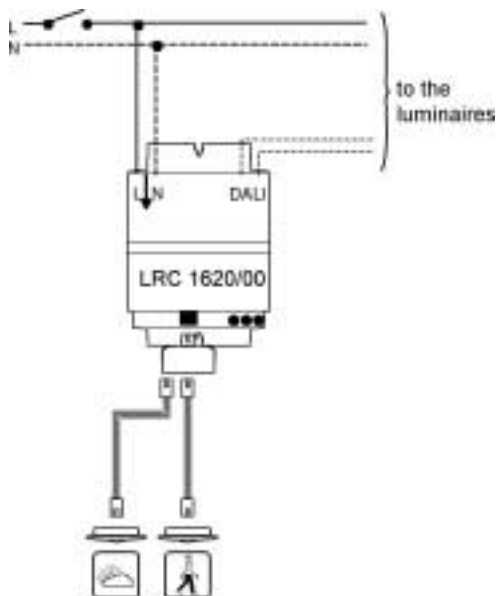

Parts list

	Quantity	Type
	1	TRIOS DALI LRC 1620 Surface-mounted version DALI control unit
	1	Daylight sensor LRL 8101
	1	Movement sensor LRM 8112 LRM 8115
	or 1	Multisensor LRI 8133 Alternative product for LRM and LRL
	1	Branching connector LCC 8024
	1	Sensor line LCC 8014 5m plug/plug

Programming

See chapter on programming and notes on daylight-controlled light regulation – Programming will require the temporary connection of an IR receiver IRR 8125 and a programming transmitter IRT 1090

6.12. Daylight regulation and movement-controlled lighting, with manual control, switch module and switch

Application

Rooms where the lighting must be regulated manually in accordance with daylight conditions and the light needs to be switched off automatically, e.g. conference rooms with some daylight

Function

	Switch on	Switch off	Dim	Circuits	Nominal value setting
Manual				1-5	
Automatic				2	
	at PRESET 1	at 150% of ref. light level			

Circuit diagram

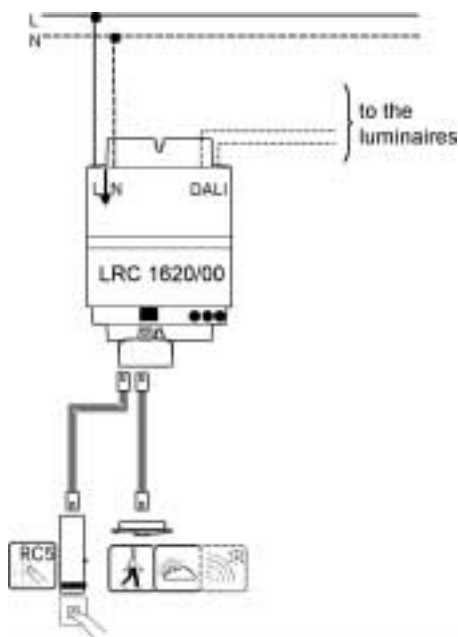

Parts list

	Quantity	Type
	1	TRIOS DALI LRC 1620 Surface-mounted version DALI control unit
		Any pulse-operated switch
	1	Multisensor LRI 8133
	1	Switch module LCU 8020
	1	Branching connector LCC 8024
	2	Sensor line LCC 8014 5m plug/plug

Programming

See chapter on programming and notes on daylight-controlled light regulation

No daylight control: P2, P3, P4 – Programming will require the temporary connection of an IR receiver IRR 8125 and a programming transmitter IRT 1090

6.13. Daylight regulation and movement-controlled lighting, with manual control, infrared remote control

Application

Suitable for modern and multi-functional lighting systems where the user wishes to adjust the lighting conditions from his workplace.

Function

	Switch on	Switch off	Dim	Circuits	Nominal value setting
Manual				1-5	
Automatic				2	
	at PRESET 1	at 150% of ref. light level			

Circuit diagram

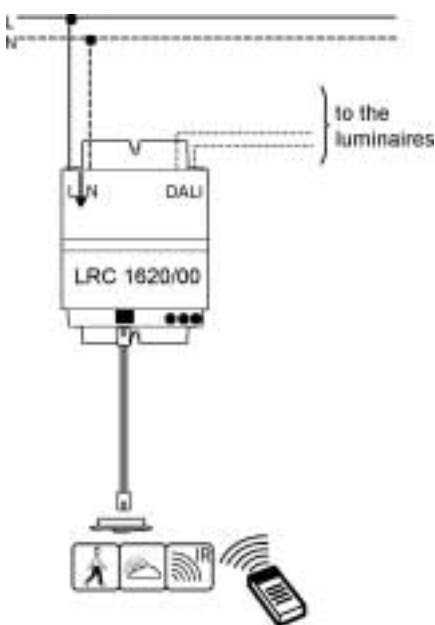

Parts list

	Quantity	Type
	1	TRIOS DALI LRC 1620 Surface-mounted version DALI control unit
	1	Multisensor LRI 8133
	Any number	IR remote control, e.g.: IRC 2130 - 5 channels, 4 scenes IRT 8050 - 2 switches
	1	Sensor line LCC 8014 5m plug/plug

Programming

See chapter on programming and notes on daylight-controlled light regulation







No daylight control: P2, P3, P4 – Programming will require the temporary connection of a programming transmitter IRT 1090

6.14. Daylight regulation and movement-controlled lighting, with manual control, infrared remote control and push-button interface

Application

Suitable for modern and multi-functional lighting systems where the user wishes to adjust the lighting conditions from his workplace.





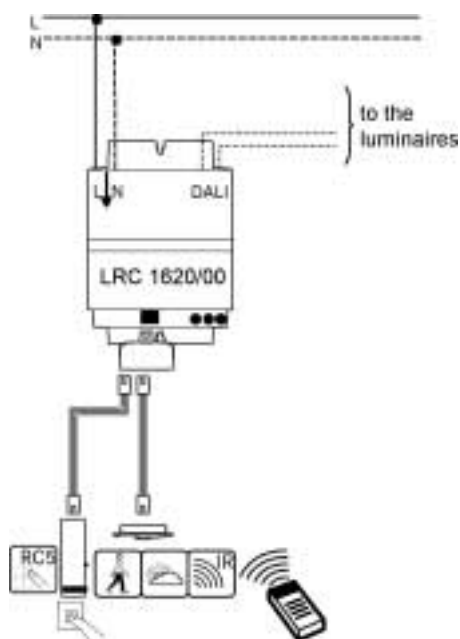

Function

	Switch on	Switch off	Dim	Circuits	Nominal value setting
Manual				1-5	
Automatic				2	
	at PRESET 1	at 150% of ref. light level			

Circuit diagram



Parts list

	Quantity	Type
	1	TRIOS DALI LRC 1620 Surface-mounted version DALI control unit
	1	Multisensor LRI 8133
	1	Switch module LCU 8020
	1	Branching connector LCC 8024
	Any number	IR remote control, e.g.: IRC 2130 - 5 channels, 4 scenes IRT 8050 - 2 switches
	1	Sensor line LCC 8014 5m plug/plug

Programming

See chapter on programming and notes on daylight-controlled light regulation. No daylight control: P2, P3, P4
– Programming will require the temporary connection of a programming transmitter IRT 1090

Programming the TRIOS DALI

7.1. Defining terms

7.1.1. Luminaire group

A luminaire group consists of one or more luminaires containing a DALI ballast. The addressing operation assigns an address to each DALI ballast or luminaire. Different luminaires can be combined into a single luminaire group (see Addressing the luminaires).

7.1.2. IR channel

If one or more luminaires are combined into a luminaire group, this, in the case of TRIOS DALI, is known as a channel. There are five IR channels, numbered from "1" to "5". Each TRIOS DALI can switch and dim up to five channels individually.



Figure 9: Five channels, each can be dimmed individually

7.1.3. PRESET

When the use of a room is changed, it is possible to change the lighting to match the new requirements. Work at a desk involving the use of a monitor for example, requires lighting quite different to that needed for a conference or for a presentation with a beamer. Individual ambiances, each tuned to a particular activity, can be created by dimming each channel and the required setting can be recorded as a "PRESET" or light scene (see Section 7.3). The personal light scenes can be instantly recalled by pressing the appropriate button of the ir transmitter. Up to four presets are possible.

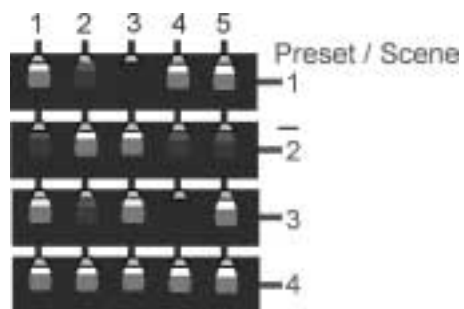

Figure 10: Four presets

Group

7.1.4.

Infrared signals radiate in space in all directions. To avoid interference between signals which have different, independent functions in the same room addresses are allocated to infrared transmitters and TRIOS units. An infrared transmitter thus controls only the TRIOS units within its own group. Units with other group addresses are not affected.

Seven groups are possible, identified with the letters "A" to "G".

Each group has its own five channels, with the possibility of generating PRESETS. The complete address of a TRIOS unit therefore consists of the channel address + group address.

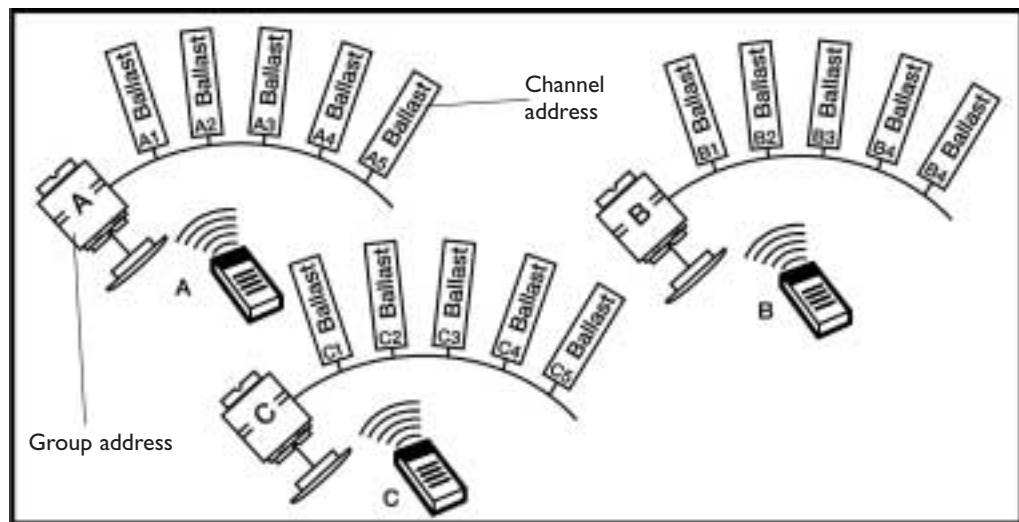

Figure 11: Schematic example of a room with three groups operated by different users

7.

7.2. Allocating addresses and assigning them to a luminaire group

Addressing can be carried out after installation has been completed. This requires an IR receiver (IRR 8125, IRR 8124) and the IRT 1090 programming remote control or the IR wall switch IRT 8050. When programming is carried out, the luminaire or luminaire group gives a confirmation by lighting up and then dimming.

7.2.1. Addressing with IRT 1090

The five steps

1 Press Mode 5 button

- All lamps light up to 100%
- Red LED on TRIOS flashes
- Lamps dim one after another to 3%
- One lamp lights up and dims

2 Channel selection

Acknowledgement: lamp dims, next lamp lights up and dims up/down

3 Step 2 is repeated

until all lamps have been addressed

4 Wait 10 seconds

5 Select group

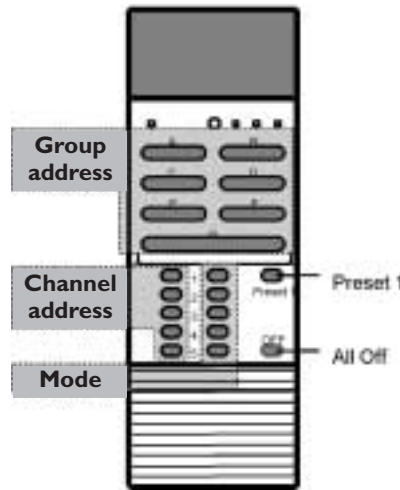

All lamps light up and dim
It is important to ensure that the distance between the IR receiver and the IRT 1090 programming remote control does not exceed 2m.

Signal transmission between the IRT 1090 and TRIOS can be tested by pressing the "P1" and "Off" buttons in succession. If the TRIOS does not respond, the cause may be one of the following:

Figure 12

Distance between TRIOS and IRT 1090 too great	Decrease distance and target more precisely
The group address of the IRT 1090 has been changed	Press buttons "C" and "D" simultaneously for more than two seconds. The left-hand red LED flashes Press button "B" as often as necessary until the three red LEDs at the top right light simultaneously. Press buttons "C" and "D" again simultaneously for more than two seconds

7.2.2. Addressing with IRT 8050

The IRT 8050 can send many different commands, but as it has only two buttons, the internal dip switches must be changed.

The five steps:

1 Press Mode 5 button

- Open remote control device
- All selector switches to ON
- Close remote control device
- Press button

All lamps go to 100%
 Red LED on TRIOS flashes
 Lamps dim in succession to 3%
 One lamp goes off

2 Channel selection

- Open remote control device
- Selector switch to position Channel 1 to 5
- Close remote control device
- Press button

Acknowledgement: Lamp lights up and dims.
 The next lamp goes to 100%

3 Repeat step 2

until all lamps have been addressed

4 Wait 10 seconds

5 Select group

All lamps light up and dim

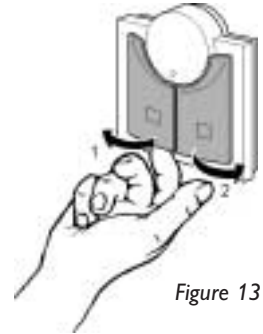

Figure 13

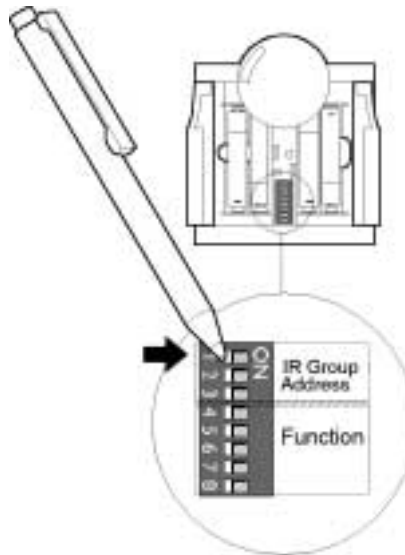

Figure 14

Selector switch assignment								Left switch	Right switch
Switch 'ON'									
1	2	3	4	5	6	7	8		
•	•	•						Channel 1 off / down	Channel 1 on / up
•	•	•	•					Channel 2 off / down	Channel 2 on / up
•	•	•		•				Channel 3 off / down	Channel 3 on / up
•	•	•	•	•				Channel 4 off / down	Channel 4 on / up
•	•	•			•			Channel 5 off / down	Channel 5 on / up
•	•	•	•	•	•	•	•	Mode 5	Mode 5

7.3. Dimming channels and defining PRESETS

7.3.1. Remote control IRC 2130

Light scenarios can comprise up to five individually dimmed channels with the TRIOS system. Once chosen, a combination of dimming values can be saved as a PRESET and recalled by simply pressing a button. The PRESET values are recorded in the individual TRIOS, not in the remote control device. Factory settings of the TRIOS DALI are P1=100%, P2=50%, P3=25%, P4=10%.

The IR remote control IRC 2130 is a tool for controlling channels and presets.

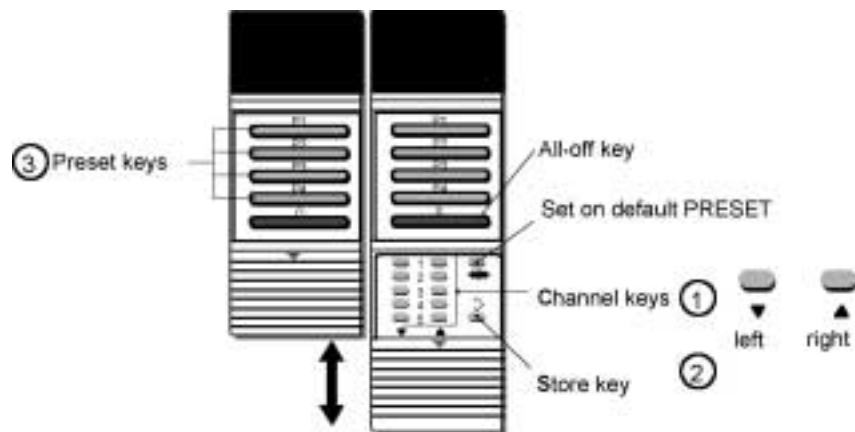

Figure 15: Function keys of the IR remote control IRC 2130

The functionality of the five pairs of channel buttons depends on the duration for which they are pressed:

- Left: short duration = "Off", long duration = dimmer
- Right: short duration = "On", long duration = brighter

The steps mentioned in Figure 15 can be used to define a new preset or to modify an existing one:

- Create the required lighting scenario by dimming the channels individually (1)
- Press "Save" (record) button (2)
- Press "Preset" button (3)

The lighting scenario has now been recorded under this PRESET button and can be called up again at any time. The group address of the IRC 2130 infrared transmitter is set using the group selector switch in the battery compartment. "All groups" is used, for example, to implement a central function.

7.3.2. Group setting IRC 2130

Group assignments are carried out on the underside of the remote control device. This device can be used by up to seven users in one room to set their specific lighting requirements in their individual zones without influencing other surrounding zones.

- 0 = All groups
- 1 = Group A
- 2 = Group B
- 3 = Group C
- 4 = Group D
- 5 = Group E
- 6 = Group F
- 7 = Group G

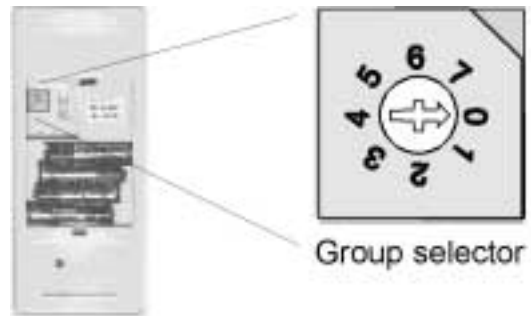

Figure 16: Group selector switch in the IRC 2130 infrared remote control

When delivery an IR transmitter is defaulted with the address "A", while a TRIOS unit has the default setting "A1".

7.3.3. Wall-mounted remote control IRT 8050

Buttons I and II on the wall-mounted remote control can be adapted to the required functions, e.g. to retrieve presets or to dim lighting.

The remote control is ready for programming as soon as batteries have been inserted:

- Set the first selector switch to the appropriate number (1-3)

7.3.4. Group setting IRT 8050

Switch position 'ON'			Group addresses
1	2	3	
			A
•			B
	•		C
•	•		D
		•	E
•		•	F
	•	•	G
•	•	•	ALL

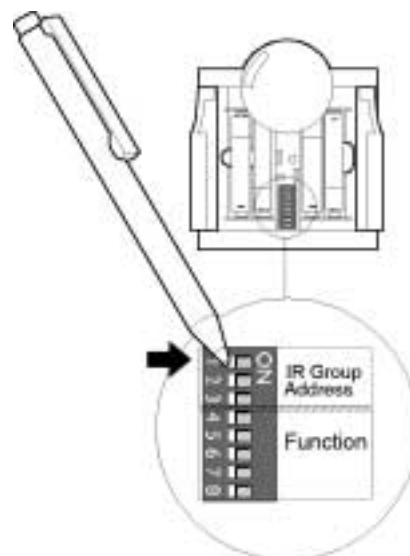

Figure 17

7.3.5. Function setting IRT 8050

Functions can be assigned to the two switches as follows:

Switch position 'ON'					Left switch	Right switch
4	5	6	7	8		
					Channel 1 off / down	Channel 1 on / up
•					Channel 2 off / down	Channel 2 on / up
	•				Channel 3 off / down	Channel 3 on / up
•	•				Channel 4 off / down	Channel 4 on / up
		•			Channel 5 off / down	Channel 5 on / up
•		•			All off	PRESET 1
	•	•			All off	PRESET 2
•	•	•			All off	PRESET 3
			•		All off	PRESET 4
	•		•		Channel 1 on ⇔ Channel 1 off	Channel 2 on ⇔ Channel 2 off
•	•		•		Channel 2 on ⇔ Channel 2 off	Channel 3 on ⇔ Channel 3 off
		•	•		Channel 3 on ⇔ Channel 3 off	Channel 4 on ⇔ Channel 4 off
•		•	•		Channel 4 on ⇔ Channel 4 off	Channel 5 on ⇔ Channel 5 off
	•	•	•		Channel 5 on ⇔ Channel 5 off	Channel 1 on ⇔ Channel 1 off
•	•	•	•		All off	PRESET 1 ⇔ PRESET 2
				•	All off	PRESET 1 ⇔ PRESET 3
•				•	All off	PRESET 1 ⇔ PRESET 4
	•			•	All off	PRESET 4 ⇔ PRESET 3
•	•			•	All off	PRESET 4 ⇔ PRESET 2
		•		•	All off	PRESET 4 ⇔ PRESET 1
•		•		•	All off	P1, P2, P3, P4
	•	•		•	All off	P4, P3, P2, P1
•	•		•	•	Mode 1	Mode 1
		•	•	•	Mode 2	Mode 2
•		•	•	•	Mode 3	Mode 3
	•	•	•	•	Mode 4	Mode 4
	•	•	•	•	Mode 5	Mode 5

7.3.6. Push-button interface LCU 8020

A remote control and the switch module have the same functions. The switch module and commercially available switches can be used to retrieve light moods or dim the lighting. The switch module LCU 8020 is connected to the TRIOS DALI controller in the same way as a sensor via an RJ 12 connecting cable.

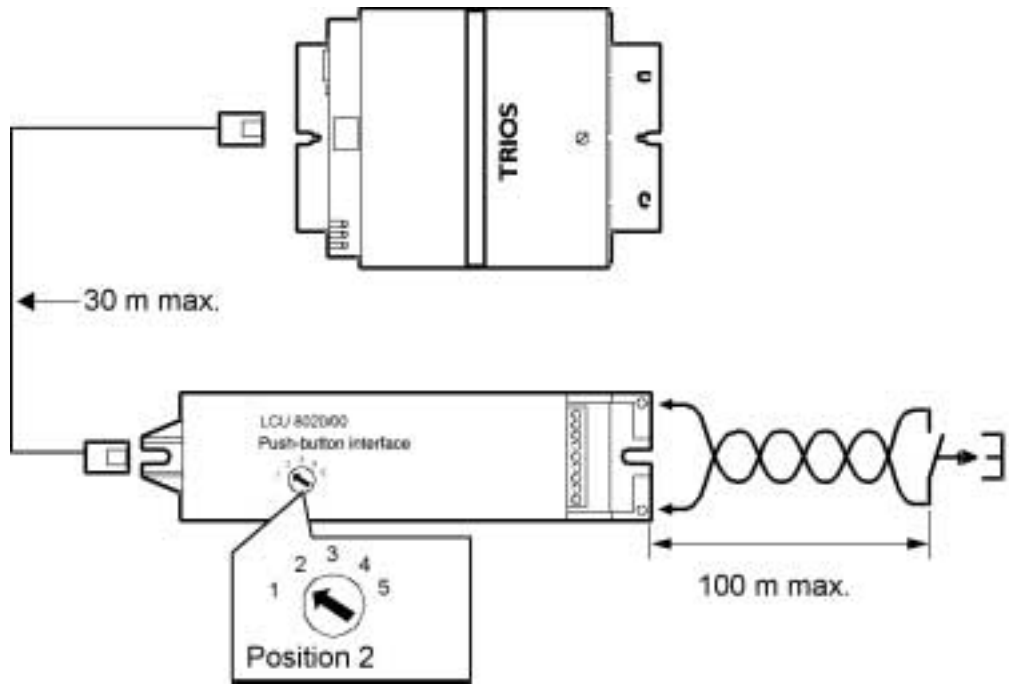

Figure 18: Connecting the push-button interface to the TRIOS

The individual switches can be assigned the corresponding functions by fitting the switches as shown in Figure 19.

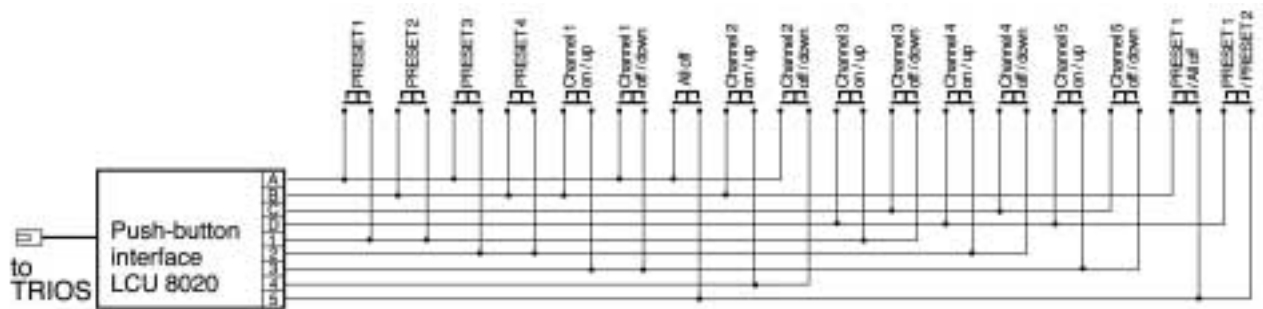

Figure 19: Switch combinations

7.4. TRIOS activation/deactivation behaviour

It is possible to change the activation and deactivation behaviour of the TRIOS as follows:

Mode selection	Function	Remote control
Mode 1 + Mode 2	Auto ON is switched off	mode 1
	Auto OFF level is 0%	mode 3
Mode 2 + Mode 3	Auto ON is switched on	mode 2
	Auto OFF level is 0%	mode 3
Mode 1 + Mode 4	Auto ON is switched off	mode 1
	Auto OFF level is 3%	mode 4
Mode 2 + Mode 4	Auto ON is switched on	mode 2
	Auto OFF level is 3%	mode 4

This feature can be used to create applications where automatic switch-on or switch-off to 0% is not required. Example: Security lighting in corridors or hospitals. Programming is carried out using the IRT 1090 or IRT 8050 remote control units. Each change of mode generates a confirmation. The luminaires dim and light up.

Notes on daylight-controlled light regulation

8.1. Difference between "control" and "regulation"

Unlike a control unit, a regulator ensures that the required illuminance will be maintained. A control unit executes a command without recording the result.

Example: Window blind control

A regulator records the result of the operation and can correct it if necessary.

Example: Radiator thermostat

The process of checking the result of such an operation and comparing it with the required value is called "feedback" and distinguishes a regulator from a control unit.

8.2. Principle of the light regulation circuit

Daylight and artificial light combine to provide illuminance at user level, i.e. generally speaking, on the working plane such as a desk or workbench. The process of automatic regulation of the output (luminous flux) of the lighting installation according to the varying contribution of natural light is destined to maintain constant the predefined level of illuminance on the working plane. This is achieved by the system making a continuous comparison between the required illuminance and the total illuminance resulting from the natural and artificial light reflected from the working plane and received by a sensor.

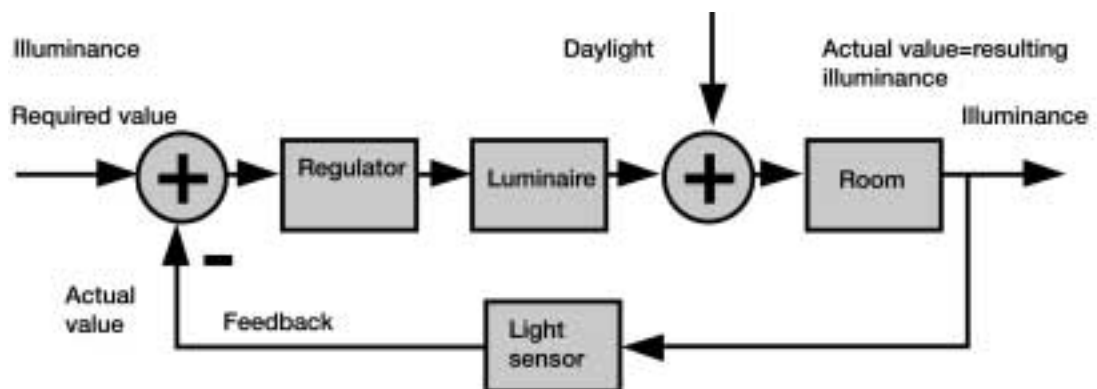

Figure 20: Operating principle of an automatic light regulation system

In order to measure correctly the total illuminance, the light sensor must be placed directly above the user level (cf. Section 6.3). Any other positioning of the sensor would result in erroneous feedback to the system and consequently in unsatisfactory functioning. Section 6.8.1 explains how the required illuminance level can be set with the TRIOS DALI system. Correct operation of the regulating circuit can only be ensured if all the components in the circuit, i.e. regulator (e.g. TRIOS), ballast, lamp and sensor, are tuned to each other. Ideally they should be supplied by the same manufacturer, since, despite the extensive standardisation of the technology used, tolerances and differences in detail can occur between different manufacturers, and this in turn can result in functional problems.

8.3. Daylight-dependent switching or dimming?

Automatic daylight-linked regulating systems save energy and costs by gradually dimming and extinguishing the lighting installation as soon as adequate natural light is available.

Medical research and practical experience prove that a sudden drop of 10% in the illuminance level in a room has a disruptive effect on people present. If the artificial light in an office is suddenly switched off everyone will look up and concentration will be disturbed.

Progressive dimming prior to extinction, balanced by increasing natural light, makes the switching-off operation virtually imperceptible as this occurs at a level much lower than the critical 10% threshold.

The importance of the quality of an artificial lighting installation should be seen as being proportional to the acuteness of the visual tasks to be carried out in the room. In offices an installation with high-frequency operation and a daylight-linked dimming function is therefore recommended.

8.4. Tips for positioning the light sensor

The light sensor must be directed towards a working plane which offers good and consistent reflection characteristics.

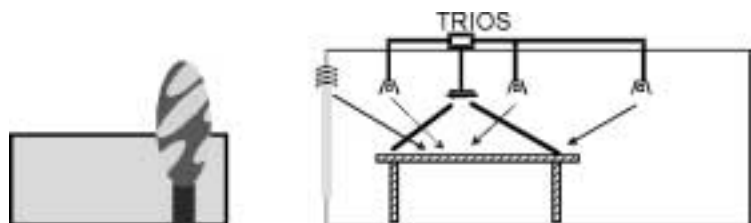

Figure 21: Sensor fitted above the working plane; the illustration shows a room with a window at the side.

As explained in Section 6.2, the sensor must be fitted above the illuminated working plane, so that it receives light reflected from that plane. Since the sensor measures the total illuminance resulting from natural and artificial light, influences such as obstructions in front of windows, shadows caused by window blinds and ageing of the lighting system itself are automatically taken into account.

No direct light must reach the sensor. Direct light from the window must be avoided as must light radiated upwards by, for example free standing or suspended direct / indirect luminaires. Sensors are in fact best installed at the same height as the luminaires. Since the working plane serves as a reflecting surface, it should be used as a reference for the entire room and should not be subject to fluctuations in its reflection factor. It is, for example, not advisable to fit the light sensor directly above a light-coloured floor which is occasionally used for storing dark coloured goods.

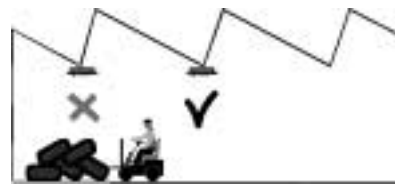

Figure 22: Sensor fitted above areas with consistent reflective properties.

8.4.1. Light sensor recording range

The design of the latest light sensors has been matched to the needs of modern office work spaces.

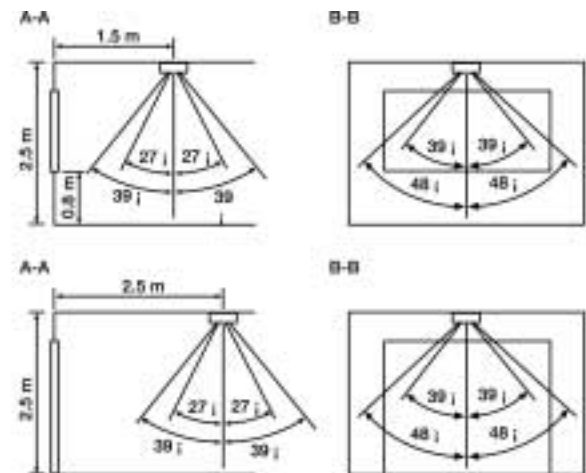
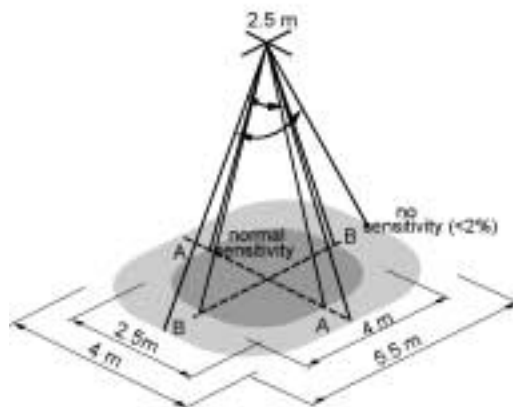

Figure 23: Light sensor sensitivity.

8.4.2. Light regulation with lateral windows

Regulation close to windows

As a general rule, daylight-controlled regulation is effective to a depth in the room which corresponds to approximately twice the height of the window. In office areas with usual dimensions, this distance will be some 3 to 5 m. At points further from the windows, the penetration of natural light will be too low to be useful as a component of the overall illuminance for working. In case of doubt, a comparative measurement between the indoor and outdoor illuminance will help. If the difference is less than 1%, regulation will not be worthwhile.

Figure 24 shows the recommended position for a light sensor in a room with a window at the side.

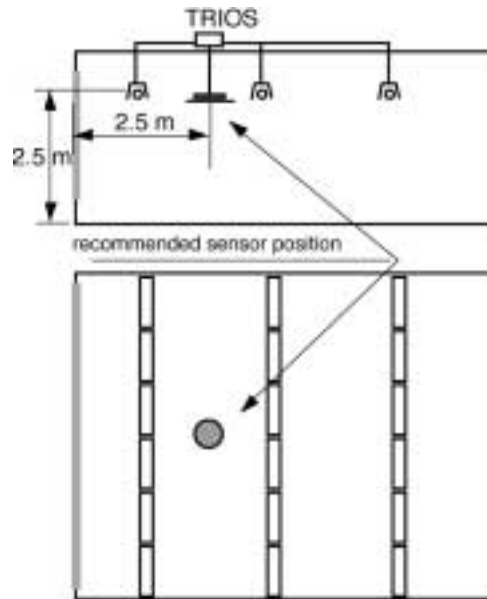

Figure 24: Sensor position in a room with window located at the side

To prevent direct light falling on the sensor, the installation aids moulded on the sensor components should be aligned as shown in Figure 25.

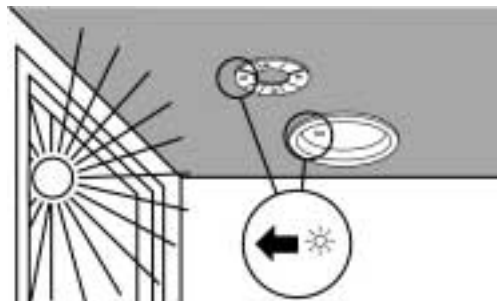

Figure 25: Alignment of the installation aids moulded on the sensor components.

There may never be sufficient daylight in the shadow of large cupboards or machinery. Such zones must not be used as reflecting work planes for installation and setting of light sensors.

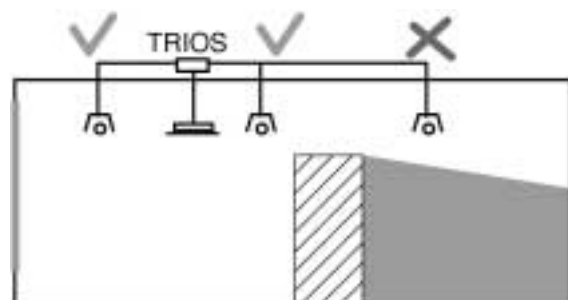

Figure 26: No daylight regulation over areas in shadow.

8.4.3. Regulation of overhead lights

Full coverage possible

In rooms where overhead lights are arranged at regular intervals (e.g. sheds with double-ridged roof), daylight regulation of all luminaires is generally a good solution. The sensor can be fitted anywhere.

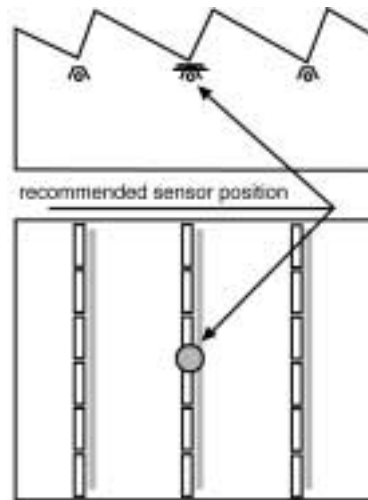

Figure 27: Sensor position in a hall with overhead lighting

Here, too, areas which are in shadow should remain unregulated, and the sensor should be installed above a surface (work plane) offering the most constant and representative reflection properties. The LRL 8101/20 can be used for room heights up to 8m.

8.5. Multiple regulation zones in a single room

Safety distance prevents interference between the zones. A large room or hall is best divided into several regulation zones. The subdivision can be based on the division of the room itself, otherwise 100m² - 200 m² per zone is a useful value.

The regulation zones must not be allowed to influence each other. Light sensors should therefore be positioned in the centre of their respective regulation zone wherever possible. The distance to the nearest luminaire in the adjacent regulation zone should not be less than the installation height of the sensors.

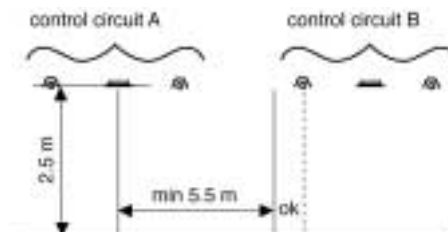

Figure 28: Minimum distances where multiple regulation zones are used

Daylight-controlled regulation

8.6.

The TRIOS DALI multifunctional light controller LRC 1620 is ideal for daylight-controlled regulation. The following illustration shows the operating cycle.

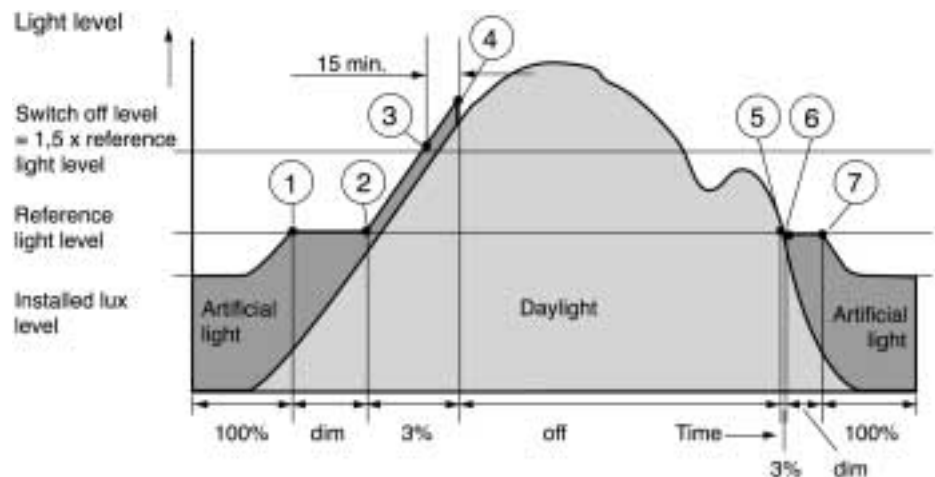

Figure 29: Regulation cycle for dimmable luminaires

With increasing daylight the total of the natural and artificial light matches the value of total illuminance calibrated in the controller. ① The calibration procedure is described below. TRIOS DALI regulates the artificial light continuously until the minimum dimming setting ② is reached, ensuring that the required illuminance level is constantly maintained. As soon as the total illuminance exceeds 1.5x the preset level ③, a waiting time of 15 min. is initiated, and TRIOS DALI then switches off the artificial lighting ④. This combination of limit value and waiting time is preprogrammed into TRIOS DALI to obviate unnecessary and disturbing switching on and off of the lighting in response to momentary and minor changes of weather conditions. If the circuit is designed with an automatic re-activation feature TRIOS DALI will switch on the lighting installation again as soon as the daylight level falls below the fixed threshold ⑤. The dimming sequence then ensues in reverse order ensuring constant illuminance balancing decreasing natural light and increasing artificial light ⑥ ⑦.

8.6.1. Master / slave programming

Connection of a light sensor informs the TRIOS DALI controller that daylight-linked regulation is required. By assigning channels 1 and 2, it is possible to obtain a 'master / slave' circuit. The 'master' luminaires nearest the window will automatically dim as daylight increases. The 'slave' luminaires, installed further from the windows where the daylight penetration is less, will also dim but not to so low a level as the 'master' luminaires. When adequate daylight is available the 'master' luminaires will automatically switch off and the 'slave' luminaires will be dimmed further. Maximum energy saving is achieved whilst a balanced lighting level is constantly maintained over the whole room.

Programming the master / slave circuit	
Channel 1 on / off	Master / slave luminaires switch on or off
Channel 1 up / down	This function can be used to set the reference light level of the master (regulation is switched off during this process)
Channel 2 on / off	No function in this application
Channel 2 up / down	This function can be used to set the level of the slave luminaire relative to the master luminaire. The level can be set as identical, lower, or higher. Generally it will be higher

8.6.2. Setting the required value

Fast setting, can be changed at any time; using IR remote control.

Preparations:

Obscure the windows. Measure the artificial light level (illuminance) with a lux meter.

If it is not possible to exclude natural light, measure the illuminance of the natural light on the working plane below the light sensor with the artificial light switched off. If the value lies above the required level of illuminance, the measurements must be made again after nightfall

With the artificial light switched on, measure the illuminance on the working plane.

Setting:

If an IR remote control or RC5 Push button interface + switch is connected:

Set the required value by pressing the channel buttons (light up / dim). Five seconds after the time the last button is pressed, TRIOS DALI records the new illuminance level set as the required level. This level can also be recorded a PRESET: up to four different PRESET levels can be recorded for push-button selection.

Settings can be changed at any time; using a screwdriver. Settings can also be carried out on the light sensor when using dimmable systems, but this is a relatively complicated operation compared to the processes described above.

The red LED indicates the operating range of the sensor, though this is not relevant for fine adjustment. While the unit is adjusting, ensure that nothing obstructs the detection area of the sensor. If the LED does not light up, position the sensor over a brighter surface.

Preparations:

Obscure the windows the artificial light level (illuminance) with a lux meter.

If it is not possible to exclude natural light, measure the illuminance of the natural light on the working plane below the light sensor with the artificial light switched off. If the value lies above the required level of illuminance, the measurements must be made after nightfall.

With the artificial light switched on, measure the illuminance on the working plane.

Setting:

Lighting level too low:

Turn the screw in counter-clockwise direction until the required level is obtained.

Lighting level too high:

Turn the screw in clockwise direction until the required level is obtained.

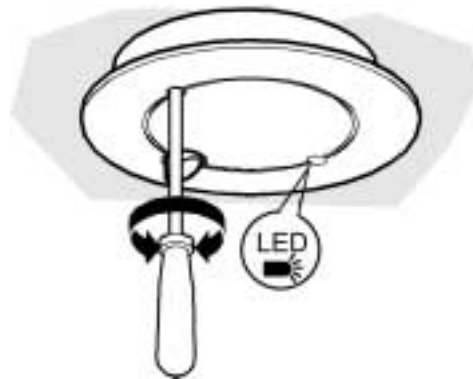

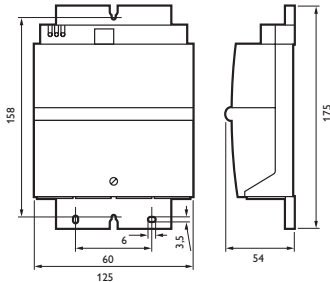

Figure 30: Setting the required value by matching the sensitivity of the LRL 8101 sensor using a size 0 screwdriver.

Product overview

LRC 1620 TRIOS DALI Room controller

EOC: 8711500 74751830



Philips no.: 9137 005 22403

Dimensions in mm	
	
Description	Technical data
<p>TRIOS DALI multifunctional light controller for local room-based installation. Offers pre-defined functions for the connection of movement detectors, infrared receivers and/or a light sensor. TRIOS DALI is specifically designed for DALI ballasts and energy saving lighting solutions with dimmable light.</p>	<p>Environmental conditions</p> <ul style="list-style-type: none"> - Ambient temperature +5 to +55°C <p>Mains</p> <ul style="list-style-type: none"> - U_{in}: 230V \pm 10% 50/60Hz - P_{dis}: 7W - I_{in}: 40mA - Pf: 0.75 <p>DALI interface</p> <ul style="list-style-type: none"> - Max. 20 DALI ballasts

IRC 2130 Infrared hand-held transmitter

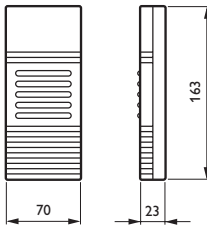

EOC: 8711500 74644330

Philips no.: 9137 005 21203

Dimensions in mm	
	
Description	Technical data
<p>Four-preset, hand-held/wall-mounted infrared remote control transmitter for use with TRIOS DALI light controllers. Incorporates programming and storage capacity for four presets and five channels.</p>	<p>Environmental conditions</p> <ul style="list-style-type: none"> - Ambient temperature +5 to +55°C <p>Power supply</p> <ul style="list-style-type: none"> - 4 alkaline dry batteries, type LR03 1.5V <p>Transmission codes</p> <ul style="list-style-type: none"> - RC5 <p>Weight</p> <ul style="list-style-type: none"> - 180g (with batteries)

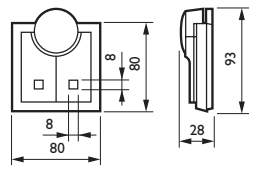

IRT 8050 Infrared transmitter for wall mounting

EOC: 8711500 74645030 Philips no.: 9137 005 21303

<p>Dimensions in mm</p> 	
<p>Description</p> <p>Multipurpose infrared remote control transmitter for wall mounting. Dedicated functions can be allocated to the two push buttons on the front side.</p>	<p>Technical data</p> <p>Environmental conditions - Ambient temperature +5 to +55°C Power supply - 4 alkaline dry batteries, type LR03 1.5V Transmission codes - RC5 Weight - 115g (With batteries)</p>

IRT 1090 Infrared programming transmitter

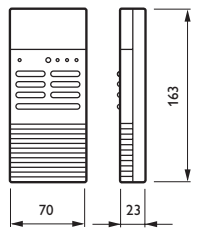
EOC: 8711500 74646730 Philips no.: 9137 005 21403

<p>Dimensions in mm</p> 	
<p>Description</p> <p>Hand-held infrared remote control transmitter for easy programming of TRIOS DALI controllers.</p>	<p>Technical data</p> <p>Environmental conditions - Ambient temperature +5 to +55°C Power supply - 4 alkaline dry batteries, type LR03 1.5V Transmission codes - RC5 Weight - 180g</p>

LRI 8133 Multisensor

EOC: 8711500 74639930

Philips no.: 9137 005 20703

Dimensions in mm		
Description	Technical data	
<p>Multisensor combining infrared receiver, movement detector and light sensor for the remote and automatic control of lighting systems. The three sensors can be selected individually. A flanged ring for recessed mounting and a plate for surface mounting are supplied.</p>	<p>Environmental conditions</p> <ul style="list-style-type: none"> - Ambient temperature +5 to +55°C <p>Power supply</p> <ul style="list-style-type: none"> - 12 V ± 10 % 20mA <p>Electrical connections</p> <ul style="list-style-type: none"> - Telejack RJ 12 <p>Weight</p> <ul style="list-style-type: none"> - 90g 	

LRM 8112 Movement detector

EOC: 8711500 74639930

Philips no.: 9137 005 20703

Dimensions in mm		
Description	Technical data	
<p>Movement detector for the automatic control of lighting systems. Provided with adjustable switch-off delay times from 0 to 45 mins. A flanged ring for recessed mounting and a plate for surface mounting are supplied.</p> <p>Movements are detected in an almost circular zone of approx. 8m. diameter.</p>	<p>Environmental conditions</p> <ul style="list-style-type: none"> - Ambient temperature +5 to +55°C <p>Power supply</p> <ul style="list-style-type: none"> - 12 V ± 10 % 10mA <p>Electrical connections</p> <ul style="list-style-type: none"> - Telejack RJ 12 <p>Weight</p> <ul style="list-style-type: none"> - 90g <p>Detection area</p> <ul style="list-style-type: none"> - Ø 8m at a mounting height of 2.6 to 3m 	

LRM 8115 Movement detector for wall mounting

EOC: 8711500 74641230 Philips no.: 9137 005 20903

Dimensions in mm	
Description	Technical data
<p>Wall-mounted movement detector for the automatic control of lighting systems. Provided with adjustable switch-off delay times from 0 to 35 mins., it detects the slightest movement in e.g. a corridor 3m wide and 25m long. The sensor has a built-in daylight override function that increases the energy-saving potential of the solution.</p>	<p>Environmental conditions - Ambient temperature +5 to +55°C Power supply - 12V ± 10 % 10mA Electrical connections - Telejack RJ 12 Detection area - 25m x 3m width at a mounting height of 2.6 to 3m</p>

LRL 8101 Light sensor



EOC: 8711500 74640530 Philips no.: 9137 005 20803

Dimensions in mm	
Description	Technical data
<p>Light sensor for automatic daylight regulation. A flanged ring for recessed mounting and a plate for surface mounting are supplied.</p>	<p>Environmental conditions - Ambient temperature +5 to +55°C Power supply - 12V ± 10 % 10mA Electrical connections - Telejack RJ 12 Weight - 90g Sensitivity - 50 to 20 000 lux</p>

IRR 8124 Infrared receiver

EOC: 8711500 74647530

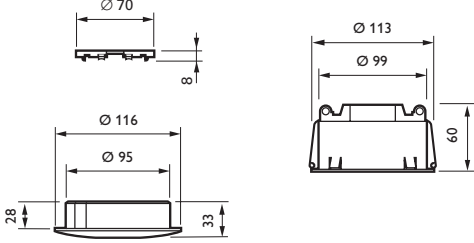

Philips no.: 9137 005 20503

<p>Dimensions in mm</p> 	
<p>Description</p> <p>Infrared receiver for the remote control of lighting systems. A flanged ring for recessed mounting and a plate for surface mounting are supplied.</p>	<p>Technical data</p> <p>Environmental conditions</p> <ul style="list-style-type: none"> - Ambient temperature +5 to +55°C <p>Power supply</p> <ul style="list-style-type: none"> - 5 V ± 10 % 3mA <p>Electrical connections</p> <ul style="list-style-type: none"> - Telejack RJ 12 <p>Weight</p> <ul style="list-style-type: none"> - 90g <p>Sensitivity</p> <ul style="list-style-type: none"> - 30 square metres enclosed by 3 walls

IRR 8125 "Invisible" IR receiver

EOC: 8711500 74638230

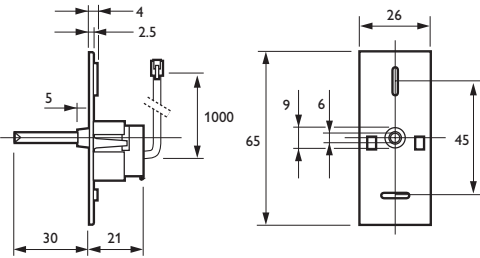
Philips no.: 9137 005 20603

<p>Dimensions in mm</p> 	
<p>Description</p> <p>Infrared receiver for remote control lighting systems with a standard connecting cable of 500 mm.</p>	<p>Technical data</p> <p>Environmental conditions</p> <ul style="list-style-type: none"> - Ambient temperature +5 to +55°C <p>Power supply</p> <ul style="list-style-type: none"> - 5 V ± 10 % 1mA <p>Electrical connections</p> <ul style="list-style-type: none"> - cable with Telejack RJ 12 <p>Weight</p> <ul style="list-style-type: none"> - 30g <p>Sensitivity</p> <ul style="list-style-type: none"> - 30 square metres surrounded by 3 walls

LCU 8020 Push-button interface

EOC: 8711500 74643630 Philips no.: 9137 005 21103

Dimensions in mm	
Description	Technical data
<p>Push-button interface. RC 5 code generator with digital inputs for connection of push-buttons. Intended for manual control of lighting controllers. The unit is connected to the infrared remote control input of the controller.</p>	<p>Environmental conditions - Ambient temperature +5 to +55°C Power supply - 12V ± 10 % 5 mA Electrical connections - cable with Telejack RJ 12 Weight - 77g</p>

LCC 8011 Interlink cable 1m

EOC: 8711500 74649830 Philips no.: 9137 005 21703

Description
<p>Interlink cable of 1 m length with modular plugs at each end for interconnect of TRIOS DALI light controllers.</p>

LCC 8012 Extension cable 5m

EOC: 8711500 74650430 Philips no.: 9137 005 21803

Description
<p>Extension cable of 5 m length with modular plug and socket. Suitable as connection or extension lead between sensors and controllers.</p>

LCC 8013 Extension cable 20m

EOC: 8711500 74651130 Philips no.: 9137 005 22003

Description	
Sensor cable of 20 m length with modular plug and socket. Suitable as connection or extension lead between sensors and controllers.	

LCC 8014 Sensor cable 5m

EOC: 8711500 74652830 Philips no.: 9137 005 20803

Description	
Interlink cable of 1 m length with modular plug at each end for interconnect of TRIOS DALI light controllers.	

LCC 8024 3 Branching connector

EOC: 8711500 74653530 Philips no.: 9137 005 21103

Description	
Branching connector with three modular sockets and one modular plug for connection of a light sensor and multiple infrared receivers and movement detectors to one TRIOS DALI light controller input.	